

cited in the European Search Report of EP 09 15 5333.9
Your Ref.: OPP-12-2003-0104-EP-C1/DISC

(12) INTERNATIONAL APPLICATION PUBLISHED UNDER THE PATENT COOPERATION TREATY (PCT)

(19) World Intellectual Property Organization
International Bureau



(43) International Publication Date
17 March 2005 (17.03.2005)

PCT

(10) International Publication Number
WO 2005/024792 A2

- (51) International Patent Classification⁷: **G11B**
- (21) International Application Number:
PCT/KR2004/002209
- (22) International Filing Date:
2 September 2004 (02.09.2004)
- (25) Filing Language: English
- (26) Publication Language: English
- (30) Priority Data:
10-2003-0062674
8 September 2003 (08.09.2003) KR
10-2003-0071127 13 October 2003 (13.10.2003) KR
10-2004-0036073 20 May 2004 (20.05.2004) KR

- (74) Agents: **BAHNG, Hae Cheol** et al.; KBK & Associates, 15th Floor Yo Sam Building, 648-23, Yeoksam-dong, Kangnam-gu, Seoul 135-080 (KR).
- (81) Designated States (unless otherwise indicated, for every kind of national protection available): AE, AG, AL, AM, AT, AU, AZ, BA, BB, BG, BR, BW, BY, BZ, CA, CH, CN, CO, CR, CU, CZ, DE, DK, DM, DZ, EC, EE, EG, ES, FI, GB, GD, GE, GH, GM, HR, HU, ID, IL, IN, IS, JP, KE, KG, KP, KR, KZ, LC, LK, LR, LS, LT, LU, LV, MA, MD, MG, MK, MN, MW, MX, MZ, NA, NI, NO, NZ, OM, PG, PH, PL, PT, RO, RU, SC, SD, SE, SG, SK, SL, SY, TJ, TM, TN, TR, TT, TZ, UA, UG, US, UZ, VC, VN, YU, ZA, ZM, ZW.
- (84) Designated States (unless otherwise indicated, for every kind of regional protection available): ARIPO (BW, GH, GM, KE, LS, MW, MZ, NA, SD, SL, SZ, TZ, UG, ZM, ZW), Eurasian (AM, AZ, BY, KG, KZ, MD, RU, TJ, TM), European (AT, BE, BG, CH, CY, CZ, DE, DK, EE, ES, FI, FR, GB, GR, HU, IE, IT, LU, MC, NL, PL, PT, RO, SE, SI, SK, TR), OAPI (BF, BJ, CF, CG, CI, CM, GA, GN, GQ, GW, ML, MR, NE, SN, TD, TG).

- (71) Applicant (for all designated States except US): **LG ELECTRONICS INC.** [KR/KR]; 20, Yoido-dong, Youngdungpo-gu, Seoul 150-721 (KR).
- (72) Inventor; and
- (75) Inventor/Applicant (for US only): **PARK, Yong Cheol** [KR/KR]; 215-204, Jugong APT., Wonmun-dong, Gwachon-si, Gyeonggi-do 427-740 (KR).

Published: — without international search report and to be republished upon receipt of that report

[Continued on next page]

(54) Title: WRITE-ONCE OPTICAL DISC, AND METHOD AND APPARATUS FOR RECORDING MANAGEMENT INFORMATION ON THE WRITE-ONCE OPTICAL DISC

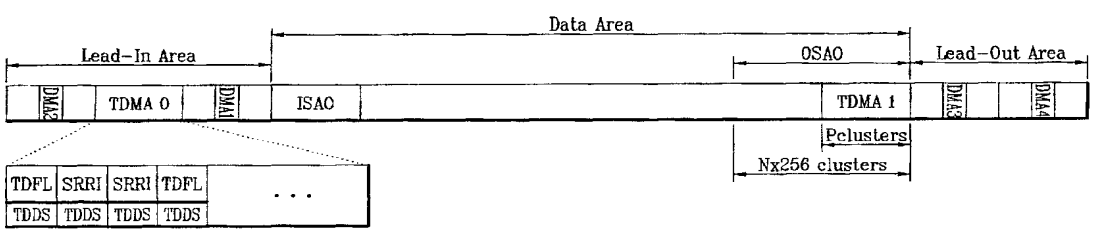

- * DMA : Disc Management Area
- * TDMA : Temporary DMA
- * ISA : Inner Spare Area
- * OSA : Outer Spare Area
- * TDFL : Temporary Defect List
- * TDDS : Temporary Disc Definition Structure
- * SRR : Sequential Recording Range
- * SRR : SRR Information

(57) Abstract: A write-once optical disc and a method and apparatus for recording management information of the write-once optical disc, are provided. The method includes sequentially recording data in the at least one recording-unit in the direction of increasing address; padding, with padding data, a remaining non-recorded part of a last recording-unit when terminating the sequential recording of the data; and recording padding identification information on the recording medium, the padding identification information identifying which part of the at least one recording-unit is padded.

WO 2005/024792 A2

**WRITE-ONCE OPTICAL DISC, AND METHOD AND APPARATUS FOR
RECORDING MANAGEMENT INFORMATION ON THE WRITE-ONCE
OPTICAL DISC**

5 **Technical Field**

The present invention relates to a write-once optical disc, a method for recording management information of the write-once optical disc and a method and apparatus for recording and playing back the write-once optical disc.

10

Background Art

As an optical recording medium, optical discs on which high-capacity data can be recorded are widely being used. Among them, a new high-density optical recording medium (HD-DVD), for example, a Blu-ray disc, has been recently developed for recording and storing high-definition video data and high-quality audio data for a long term period.

The Blu-ray disc is the next generation HD-DVD technology and the next generation optical recording solution, and has an excellent capability to store data more than the existing DVDs. Recently, a technical specification of international standard for HD-DVD has been established. Related with this, various standards for a write-once Blu-ray disc (BD-WO) are being

prepared following the standards for a rewritable Blu-ray disc (BD-RE).

Among the standards for the write-once Blu-ray disc (BD-WO), a method for recording management information has been discussed. This method involves a recording method of an information indicating a recording status
5 of the disc, which is one of the characteristics of the write-once optical disc.

The information indicating the recording status of the disc allows a host or a user to easily find a recordable area on the write-once optical disc. In the existing write-once optical discs, this information is named variously. For example, in the case of CD series, this information is named a track
10 information; in the case of DVD series, this information is named an RZone or a fragment.

Accordingly, there is an increasing demand for a method of efficiently recording the management information corresponding to the recording status of the high-density optical disc. And this method must be provided
15 with the standardized information in order to secure mutual compatibility.

In addition, there is a demand for a method of recording the management information on a disc, which can be applied to a write-once high-density optical disc performing defect management, as well as to the Blu-ray discs.

20 **Disclosure of Invention**

Accordingly, the present invention is directed to an optical disc and a

method and apparatus for recording disc management information, and particularly to a method and apparatus for efficiently managing the disc recording status information, which substantially obviate one or more problems due to limitations and disadvantages of the related art.

5 An object of the present invention is to provide a method and apparatus for defining types of sequential recording ranges (SRRs) and recording information on the SRRs in an SRR information (SRRI).

Another object of the present invention is to provide a method and apparatus for recording SRRI as disc recording status information that can
10 be applied to a write-once optical disc on which physical defect management is performed, and to provide a method and apparatus for recovering a damaged SRRI from a write-once optical disc.

Additional advantages, objects, and features of the invention will be set forth in part in the description which follows and in part will become apparent to
15 those having ordinary skill in the art upon examination of the following or may be learned from practice of the invention. The objectives and other advantages of the invention may be realized and attained by the structure particularly pointed out in the written description and claims hereof as well as the appended drawings.

20 It is to be understood that both the foregoing general description and the following detailed description of the present invention are exemplary and

explanatory and are intended to provide further explanation of the invention as claimed.

Brief Description of Drawings

- 5 The accompanying drawings, which are included to provide a further understanding of the invention and are incorporated in and constitute a part of this application, illustrate embodiment(s) of the invention and together with the description serve to explain the principle of the invention. In the drawings:
- 10 FIG. 1 illustrates an overall structure of a write-once optical disc and a method for recording management information on the write-once optical disc according to the present invention;
- FIGs. 2A through 2D illustrate different types of opened SRRs of a write-once optical disc according to the present invention;
- 15 FIGs. 3A through 3E illustrate different types of closed SRRs of a write-once optical disc according to the present invention;
- FIG. 4A illustrates an example of padding identification information when padding dummy data to a closed SRR of a write-once optical disc according to the present invention;
- 20 FIG. 4B illustrates an example of padding identification information when padding dummy data to an opened SRR of a write-once optical disc

according to the present invention;

FIG. 5 illustrates an overall structure of a write-once optical disc and a method for recording SRRI as disc management information according to the present invention;

5 FIG. 6A illustrates a structure of an SRR entry list recorded in an SRRI according to the present invention;

FIG. 6B illustrates an example of an SRR entry recorded in the SRR entry list of FIG. 6A according to the present invention;

10 FIG. 6C illustrates an example of a structure of a list of opened SRRs field of an SRRI according to the present invention;

FIGs. 7A through 11B illustrate a process of recording SRRI according to the disc recording status in a write-once optical disc according to the present invention; and

15 FIG. 12 is a flowchart illustrating a method of using SRRIs of a write-once optical disc when the latest SRRI is damaged according to an embodiment of the present invention;

FIGs. 13A and 13B illustrate a method of restoring the latest SRRI in the write-once optical disc according to an embodiment of the present invention; and

20 FIG. 14 illustrates a recording/playback apparatus for a write-once optical disc according to an embodiment of the present invention.

Best Mode for Carrying Out the Invention

Reference will now be made in detail to the preferred embodiments of the present invention, examples of which are illustrated in the accompanying
5 drawings. Wherever possible, the same reference numbers will be used throughout the drawings to refer to the same or like parts.

For the convenience of description, a write-once Blu-ray disc (BD-WO) is described for example. Most of the terminologies in this specification are widespread general words but there are some words selected and used by
10 the inventor, the meaning of which will be described in detail in the corresponding description. The present invention should be understood not based on the simple meanings of the words but based on the specifically described meanings of the words, if such meanings have been discussed.

When a plurality of areas are formed on a disc and the areas are recorded
15 sequentially, each of these areas is called a "sequential recording range" (SRR). An SRR is a unit of recording (sequential recording-unit) for sequential recording user data. An SRR has a size of one or more clusters. "SRR information" (SRRI) is a name for information identifying a recording status of a disc. SRRI is applied to a sequential recording mode of the disc
20 and pertains to one or more SRRs. "Padding" means filling an unrecorded area in an SRR with dummy data or zeros at a user's request or under

control of a recording/playback apparatus (FIG. 12). "Session" is composed of one or more consecutive SRRs and identifies SRRs for compatibility to the specification only for playbacks.

FIG. 1 illustrates a structure of a write-once optical disc such as a BD-WO
5 and a method for recording disc management information according to the present invention. The disc shown in FIG. 1 has a single recording layer as an example. But the present invention is not limited to such, and is applicable to a disc having dual or multiple recording layers.

Referring to FIG. 1, the disc includes a lead-in area, a data area, and a lead-
10 out area, all at the recording layer. The lead-in and lead-out areas have a plurality of disc (or defect) management areas (DMA1 – DMA4) for storing the same defect management information repeatedly. In the data area, an inner spare area ISA0 and/or an outer spare area OSA0 for replacing defective areas is provided.

15 It is known that a rewritable optical disc does not have or need a large DMA since its DMA can be written and erased repeatedly, even if the disc has the DMA of a limited size. This is not the case for a write-once optical disc such as a BD-WO. Since the write-once optical disc cannot be re-recorded on the area that was recorded once, the write-once optical disc needs and has a
20 larger management area. To more effectively store management information, in the write-once optical disc the management information is temporarily

stored in a temporary disc management area (TDMA). When the disc is ready to be finalized/closed, then the management information stored in a final/latest TDMA is transferred to a DMA for more permanent storage.

As shown in FIG. 1, the disc includes two TDMA's: TDMA0 and TDMA1. The

5 TDMA0 is allocated to the lead-in area and has a fixed, non-variable size.

The TDMA1 is allocated to the outer spare area OSA0 and has a size variable

in accordance with the size of the spare area. The size P of the TDMA1 may

be, for example, $P = (N * 256) / 4$ clusters where N is a positive integer,

which is about one fourth of the size of the entire outer spare area OSA0.

10 In each of the TDMA0 and TDMA1, temporary defect list (TDFL) information

and temporary disc definition structure (TDDS) information together (TDFL

+ TDDS) can be recorded in one recording-unit (e.g., one cluster in the case

of a BD-WO), or SRRI and TDDS information together (SRRI + TDDS) can be

recorded in one recording-unit as shown. The SRRI is recorded when a

15 sequential recording mode is used, whereas SBM (space bit map) is used

when a random recording mode is used.

At each update time, (TDFL + TDDS) or (SRRI + TDDS) are recorded to the

TDMA in the size of one cluster. In the example of FIG. 1, a TDFL and a

TDDS are recorded in one cluster of the TDMA0, an SRRI and a TDDS are

20 recorded in the next cluster of the TDMA0, an SRRI and a TDDS are

recorded in the next cluster of the TDMA0, and so on.

If a defective area occurs within the data area, a process of replacing it with the spare area is carried out. The TDFL is the information that manages this process as the defect list. In the case of a single layer disc, the TDFL is recorded with the size of 1 cluster to 4 clusters according to the size of the defect list. SRRI is information informing of whether a specific area of the disc is recorded or unrecorded. The SRRI can be widely used when the disc is of a consecutive recording type. That is, the SRRI can be usefully applied to the case where the disc is recorded in a sequential or incremental recording mode. In addition, the TDDS information is generally recorded on the last sector among the 32 sectors within one cluster of the management area. Information for general management and defect management of the disc is recorded as part of the TDDS information, and the TDDS information is generally always recorded last when the management information is updated within the TDMA.

The present invention relates to a method of generating and recording disc recording status information, which is applied to a new high density optical disc such as a BD-WO. In the present invention, SRRI is used as the disc recording status information, and various types of SRRs are defined as shown in FIGs. 2A through 3E. The detailed structure of SRRI will be described referring to FIGs. 5A through 6C. The present invention also defines and distinguishes different types of SRRs formed on the disc and

uses them to record and playback the optical disc. A method of newly defining the types of the SRRs and creating information identifying the types of distinguished SRRs will be described in detail.

FIGs. 2A to 2D illustrate different types of opened SRRs for the write-once
5 optical disc (e.g., a BD-WO) according to the present invention. An opened SRR is an SRR in which data can be recorded. If the SRR is recordable, the SRR has "next writable address" (NWA). Accordingly, the opened SRR is the SRR having the NWA. The SRR that does not have the NWA and is not recordable is called a closed SRR. The closed SRR will be described referring
10 to FIGs. 3A through 3E.

More specifically, FIG. 2A shows an invisible SRR that is one type of an opened SRR. The invisible SRR is generally always formed on an outermost section of a disc or an initial black disc and means an unrecorded area. In other words, only a start address of the invisible SRR is defined and an end
15 address of the invisible SRR means an end of user data. Since data is not yet recorded, "last recorded area" (LRA) has a zero value and the NWA has the same value as the start address of the invisible SRR.

FIG. 2B shows an incomplete SRR that is another type of an opened SRR. The incomplete SRR is an SRR that is partially recorded in the invisible SRR
20 of FIG. 2A. In other words, only a start address of the incomplete SRR is defined and an end address of the incomplete SRR means an end of user

data. However, since data is partially recorded in the incomplete SRR, the LRA of the incomplete SRR represents the last address at which normal user data is recorded and the NWA is the next address from the LRA of the incomplete SRR. That is, the NWA is the first PSN of the next available
5 unrecorded cluster in the related SRR.

In the opened SRR, if the SRR is partially recorded, the relation between the LRA and the NWA will be now described in detail in relation with padding shown in FIG. 2B. The enlarged view of the small dotted box portion in FIG. 2B is provided at a lower portion of the drawing.

10 In other words, LRA means the area in which user data are actually recorded. If the user data are recorded on some sectors in one cluster consisting of thirty-two sectors, the physical sector number (PSN) of the corresponding sector on which the user data are recorded is the LRA of the SRR as shown in FIG. 2B. However, since the basic recording-unit of the
15 Blu-ray disc is a cluster, NWA representing an additionally recordable area will be the PSN of a header sector of the following cluster. Accordingly, if data is recorded on some sectors of the cluster and recording is finished (i.e., the sequential recording is terminated), the remaining unrecorded sectors are padded with dummy data according to the present invention. For
20 instance, the remaining unrecorded sectors of the cluster are padded with zeros as shown. If all the user data are recorded on even the last sector of

the cluster, it is obvious that the padding described is not necessary.

FIG. 2C shows an empty SRR that is yet another type of an opened SRR.

The empty SRR is formed generally not at an outermost section of the disc, but is formed generally at a middle section to record data in contrast to the

5 invisible SRR and the incomplete SRR of FIGs. 2A and 2B. In other words, it is the case where a host or user makes an SRR, but does not yet record data on the SRR. Since the empty SRR has a start address and an end address but is not yet recorded, the LRA of the empty SRR has a "zero" value and the NWA has the same value as the start address of the empty SRR.

10 FIG. 2D shows a partially recorded SRR that is yet another type of an opened SRR. The partially recorded SRR is an SRR that is partially recorded in the empty SRR of FIG. 2C. Accordingly, the partially recorded SRR has a start address and an end address. Since data is partially recorded in the partially recorded SRR, the LRA of the partially recorded SRR represents the

15 last address at which normal data is recorded and the NWA is the next writable address from the LRA.

In the opened SRR of FIG. 2D, if the SRR is partially recorded, the enlarged view of the small dotted portion in FIG. 2D shows the relation between the LRA and NWA in relation with padding. The detailed description on this

20 feature is omitted since it is the same as the description of FIG. 2B.

Accordingly, referring to FIGs. 2A through 2D, the opened SRRs of the

present invention are classified into the unrecorded opened SRRs (FIGs. 2A and 2C) and the partially recorded opened SRRs (FIGs. 2B and 2D). The partially recorded opened SRRs (FIGs. 2B and 2D) can be classified into an opened SRR padded after the LRA, and an unpadded opened SRR.

5 According to the present invention, the total number of opened SRRs at any given time is limited to a predetermined number in the write-once optical disc due to a difficulty in management if the number of opened SRRs is large. For example, the total number of the opened SRRs on the disc may be sixteen at most in the BD-WO of the present invention. The information on
10 the location and the number of the opened SRRs can be referred to using a "list of opened SRRs" field and a "number of opened SRRs" field in a header of the SRRI. The "list of opened SRRs" field and the "number of opened SRRs" field in the SRRI header will be described later when the SRRI structure is discussed referring to FIGs. 5 through 6C.

15 FIGs. 3A to 3E illustrate different types of closed SRRs for a write-once optical disc such as a BD-WO according to the present invention. A closed SRR is an SRR in which data (e.g., user data) cannot be recorded. If the SRR is not recordable, the SRR does not have a NWA. The closed SRR may be created because the SRR is fully recorded. Also, the closed SRR may be
20 created because a user or host closes the SRR by a close command even though a recordable area remains in the SRR.

Particularly, FIG. 3A shows an empty SRR that is one type of a closed SRR. The empty SRR is an opened empty SRR (FIG. 2C) that is closed by a close command without any user-data recording thereto. Accordingly, FIG. 3A shows a closed empty SRR and FIG. 2C shows an opened empty SRR.

5 FIG. 3B shows a partially recorded SRR that is another type of a closed SRR. The partially recorded SRR of FIG. 3B is the opened partially recorded SRR of FIG. 2D that is closed by a close command without any additional user-data recording thereto. Accordingly, FIG. 3B shows a closed partially recorded SRR and FIG. 2D shows an opened partially recorded SRR.

10 FIG. 3C shows a complete SRR that is yet another type of a closed SRR. The complete SRR is an SRR in which user data are recorded fully in the SRR, or which is padded fully with dummy data. The complete SRR exists only among the closed SRRs.

FIG. 3D shows a closed partially recorded SRR that is yet another type of a closed SRR. The partially recorded SRR of FIG. 3D is an SRR that is padded with dummy data in a recordable area after its LRA when closing the opened partially recorded SRR of FIG. 2D. Herein, all the recordable areas or only some recordable areas (for example, one or more clusters) of the SRR after its LRA or NWA may be padded with dummy data used as padding data. In
15
20 addition, when some areas are padded, a specific character code such as ASCII characters may be recorded as the padding data, instead of recording

the dummy data so as to represent that the SRR is closed. In this case, the specific character code to be used as the padding data can be characters such as "CLSD" representing that a corresponding SRR is closed.

FIG. 3E shows an empty SRR that is another type of a closed SRR. The empty SRR of FIG. 3E is an SRR that is padded with specific dummy data in a recordable area after its LRA and then closed when closing the opened empty SRR of FIG. 2C. Herein, all the recordable areas or only some recordable area (for example, one or more clusters) of the SRR after its LRA or NWA may be padded with dummy data used as padding data. In addition, when some areas are padded, a specific character code such as ASCII characters may be recorded as the padding data, instead of recording the dummy data so as to represent that the SRR is closed. In this case, the specific character code to be used as the padding data can be characters such as "CLSD" representing that a corresponding SRR is closed.

If the closed SRRs of FIGs. 3D and 3E are fully padded with dummy data up to the end address, the closed SRRs of FIGs. 3D and 3E are the same SRRs as the complete SRR described above referring to FIG. 3C. In other words, in the present invention, in determining the type of the closed SRR, the closed SRRs are defined to distinguish the case of closing the unrecorded remaining area(s) of the SRR without padding (FIGs. 3A and 3B) from the case of padding and closing the unrecorded remaining area(s) of the SRR

(FIGs. 3D and 3E) when the opened SRR is changed into the closed SRR by a close command.

Additionally, in the present invention, when closing an SRR, it is possible to close the SRR without padding or to close the SRR after padding with
5 specific padding data. It is considered that the Blu-ray disc is compatible to a disc only for playback in the same family though SRRs or if unrecorded areas are padded. A recording/playback apparatus (e.g., as shown in FIG. 14) can selectively pad the disc so that the freedom of the design of the recording/playback apparatus is further ensured. When padding the disc, a
10 recording/playback part (e.g., the component 10 in FIG. 14) of the recording/playback apparatus can automatically record specific data, so that the component 10 receives specific data from a controller and can solve the time problem in the case of padding

FIGs. 4A and 4B illustrate examples of padding identification information
15 when padding dummy data respectively to a closed recorded SRR and an opened SRR of a write-once optical disc according to an embodiment of the present invention. The padding may be performed to an opened SRR when closing the opened SRR. But, it can also be performed to an opened SRR in response to a command not necessarily to close the SRR (e.g., in the cases of
20 FIGs. 2B and 2D where padding is performed for terminating the sequential recording). That is, FIG. 4A is related to FIG. 2B or 2D, and FIG. 4B is

related to FIG. 3D or 3E.

More specifically, FIG. 4A shows a case where the actual user data is recorded on only some areas of one cluster and the remaining areas of the cluster are padded with dummy data in the case of an opened SRR. FIG. 4A

5 shows that padding identification information "Padding_flag" for distinguishing a sector in which actual user data is recorded from a sector padded with dummy data is set as control flag in the corresponding cluster. There exist 32 Padding_flags each corresponding to one of the 32 sectors of each cluster of an SRR.

10 As shown in FIG. 4A, in this example, since sector 0 – sector 29 are the areas in which user data are recorded, the Padding_flag for each of these sectors is set to a certain value, e.g., "0b," so as to indicate that no padding is present to the corresponding sector. On the other hand, since sector 30 and sector 31 are the areas padded with padding data, the Padding_flag for
15 each of these sectors is set to a value such as "1b" so as to indicate that padding is present in the corresponding sectors.

In this example, the LRA represents the location (first PSN) of sector 29. Accordingly, the optical recording/playback apparatus can decode a cluster including the LRA, read the Padding_flag corresponding to each of the
20 sectors and then accurately recognize a sector padded with dummy data in the cluster.

FIG. 4B shows that a specific cluster of the recordable areas in an SRR is fully padded with dummy data in the case of closing the SRR. FIG. 4B shows that padding identification information "Padding_flag" for distinguishing an SRR closed without padding from an SRR closed after padding is set as control flag in the corresponding cluster.

As shown in FIG. 4B, in this example, since sector 0 – sector 31 are the areas padded fully with dummy data, the Padding_flag for each of these 32 sectors is set to a certain value such as "1b", to indicate that the corresponding sectors are padded. Consequently, the optical recording/playback apparatus can decode a cluster having the padding identification information (Padding_flag) as describe above, read the Padding_flag corresponding to each of the sectors and then accurately recognize that all the sectors in the cluster are padded with dummy data.

In other words, FIG. 4A relates to padding for terminating the sequential recording on the disc whereas FIG. 4B relates to padding for closing an SRR. FIG. 4A shows that all the remaining sectors in the related cluster are padded with dummy data when the sequential recording is terminated. Each padding flag corresponds to each sector of the cluster, and is set to "1b" if the corresponding sector is padded. In the case of FIG. 4A, padding occurs one sector at a time. On the other hand, in the case of FIG. 4B, one or more clusters (one cluster at a time) are padded when closing the SRR.

For one cluster padding, 32 padding flags corresponding to 32 sectors of that cluster are all set to "1b" to indicate the padding of that cluster as shown in FIG. 4B.

FIGs. 5 through 6C illustrate a structure of SRRI and information included
5 in the SRRI according to the present invention.

Particularly, FIG. 5 illustrates the overall structure of an SRRI. The SRRI pertains to one or more SRRs and is management information providing disc recording status. The SRRIs are recorded in TDMA(s) (e.g., the TDMA0) in the optical disc structure of FIGs. 1 and 5. As shown in FIG. 5, each SRRI
10 60 in a TDMA is composed of three parts: a header 50, a list of SRR entries 30 and an SRR list terminator 40. The header 50 identifies the SRRI. The list of SRR entries 30 represents the recording status of each of the corresponding SRRs. The SRR list terminator 40 represents an end or termination of the SRRI.

15 The header 50 is located at a header in the SRRI and includes an "SRRI structure identifier" field 51, a "List of opened SRRs" field 52, a "Number of SRR entries" field 53 and a "Number of opened SRRs" field 54, so that the overall SRR entry contents can be checked before the SRR entry list is read. Herein, the "SRRI structure identifier" field 51 identifies the SRRI. The "List
20 of opened SRRs" field 52 informs of the location (identification) of the opened SRRs associated with the corresponding SRRI and will be described later in

more detail referring to FIG. 6C. The "Number of SRR entries" field 53 represents the total number of all SRRs associated with the SRRI 60. The "Number of opened SRRs" field 54 represents the total number of opened SRRs.

5 After the header 50, the list of SRR entries (or the SRR entry list) 50 is recorded in the SRRI. After the last SRR entry, the end of the SRRI is marked with the SRR list terminator 40. The SRR list terminator 40 is meaningful as information indicating an end location of the corresponding SRRI if the SRRI has a variable size.

10 Accordingly, as disc management information, the SRRI is composed of the header 50, the SRR entry list 30 and the SRR list terminator 40. All such information is recorded in batch whenever it is updated.

FIG. 6A illustrates an example of the SRR entry list 30 recorded in an SRRI according to the present invention. As shown in FIG. 6A, the SRR entry list
15 30 is composed of one or more SRR entries 35. Each of the SRR entries 35 carries information on one SRR (identified by the SRR number) on the disc, has a size of eight bytes (64 bits) and represents the recording status of the corresponding SRR. Each SRR entry 35 includes a status field 31 (Status 1) for storing the status of the corresponding SRR, a start address field 32 for
20 storing a start address of the corresponding SRR, another status field 33 (Status 2) for storing the status of the corresponding SRR, and a last

recorded address (LRA) field 34 for storing the LRA of the corresponding SRR (i.e., the end address of the user data stored in the SRR). Generally, the start address of the corresponding SRR in the start address field 32 is represented as a physical sector number (PSN).

5 According to an embodiment, the first 4 most significant bits (b63-b60) among the 64 bits of the SRR entry 35 are allocated to the first status field 31, the next 28 bits (b59-b32) of the SRR entry 35 are allocated to the start address field 32, the next 4 bits (b31-b28) of the SRR entry 35 are allocated to the second status field 33, and the last 28 bits (b27-b0) of the SRR entry
10 35 are allocated to the LRA field 34.

FIG. 6B illustrates an example of the SRR entry 35 recorded in the SRR entry list 30 according to the present invention. The Status 1 field 31 is used to store information identifying whether or not any padding is performed in the corresponding SRR. The Status 2 field 33 is used to store
15 information identifying whether or not the corresponding SRR is the start of a session.

As shown in FIG. 6B, out of the 4 heading bits allocated to the Status 1 field 31, one bit is used to store a padding identification information "P_flag" identifying whether or not the SRR has been padded with padding data. The
20 other three bits of the 4 heading bits are reserved for any change of regulation.

It should be noted that the padding identification information "P_flag" recorded in the SRR entry is similar to the padding identification information "Padding_flag" described referring to FIGs. 4A and 4B. However, they have different objects. If a specific SRR is finally padded, the P_flag is recorded in the SRR entry to directly represent that the corresponding SRR is a padded SRR. Accordingly, the optical recording/playback apparatus (FIG. 12) can easily check whether or not the corresponding SRR is padded by examining the P_flag recorded as management information in the SRR entry. After that, the optical recording/playback apparatus decodes the corresponding cluster (SRR) described above referring to FIGs. 4A and 4B and reads from the cluster the value of the Padding_flag corresponding to each sector of the SRR, so that the optical recording/playback apparatus is able to determine how much of the SRR is padded after its LRA.

In the example of FIG. 6B, the first bit (31a) of the Status 1 field 31 carries the P-flag and the remaining 3 bits (31b) of the field 31 are reserved. If P_flag = 1b, it means that the corresponding SRR is a padded SRR (i.e., the SRR has at least some portion that is padded with padding data). If P_flag = 0b, it means that the corresponding SRR is an unpadded SRR.

The Status 2 field 33, which is allocated with 4 bits, carries information on whether or not the corresponding SRR is the session start SRR. One bit of the four-bit field 33 carries a session identification information "S_flag"

identifying whether or not the corresponding SRR is a start SRR of a session.

The other three bits of the field 33 are reserved for any change of regulation.

In the example, the first bit (33a) of the four-bit field 33 stores the S-flag and

the remaining 3 bits (33b) are reserved. If S_flag = 1b, it means that the

5 corresponding SRR is a start SRR of a session. If S_flag = 0b, it means that

the corresponding SRR is not a start SRR of a session.

One reason for identifying a start of a session through the S_flag is to

provide compatibility with existing disc structures such as DVDs that

allocate additional area (for example, border-in/border-out) to distinguish

10 sessions. However, allocation of the additional area reduces the entire

recording capacity of the disc. As such, the present invention overcomes

this limitation by providing the session identification information (S_flag) in

the SRR entry 35. Accordingly, the session structure of the entire disc can

be easily recognized using the session identification information S_flag in

15 the SRR entry 35 without having to allocate additional areas to store such

session distinguishing information.

For the convenience of description of the present invention, the P_flag and

the S_flag are depicted as separate status information stored in separate

status fields of an SRR entry, but they can be stored together in one status

20 field of the SRR entry.

The LRA field 34 of the SRR entry 35 is a field for recording an end address

(LRA) of user data recorded in the corresponding SRR and stores an end address of the user data (excluding any padding data) recorded in the corresponding SRR

FIG. 6C illustrates a detailed structure of the "List of opened SRRs" field 52

5 of the SRRI in FIG. 5 according to an embodiment of the present invention.

The information stored in the field 52 is used to determine the location/identification of each opened SRR. As shown in FIG. 6C, one or more opened SRR numbers are recoded in the "List of opened SRRs" field 52 as location information of the opened SRRs. Two bytes are allocated to

10 record an opened SRR number identifying a particular SRR.

In the present invention, if there are at most sixteen opened SRRs on the disc, the location (identification) of the corresponding opened SRRs (and thus the opened SRR entries) is recorded through each opened SRR number.

Accordingly, when loading an optical disc having the disc structure of the

15 present invention, the recording/playback apparatus can determine the location of recordable areas (NWA) of the disc based on the opened SRR information of the present invention. In other words, the location of the opened SRR on the current disc should be known to record data. Since the information identifying whether a corresponding SRR is an opened SRR or a

20 closed SRR is not provided specifically in the SRR entry, the identification/location of the opened SRR is recorded in the header of the

SRR and can be accessed easily, so that the optical recording/playback apparatus is able to easily read the SRR entry associated with the identified opened SRR.

Accordingly, only the SRR having the SRR number recorded on the "List of
5 opened SRRs" field 52 is additionally recordable as an opened SRR. After that, if the SRR is changed into a closed SRR, the SRR number of the closed SRR is removed from the "List of opened SRRs" field 52 so that it is possible to easily distinguish the opened SRR from the closed SRR.

A method for updating the SRR representing the disc recording status
10 according to the present invention will be now described. Particularly, a method of opening and closing SRRs and sessions, padding an SRR with dummy data and recording SRRs will be described referring to FIGS. 7A-11B.

FIGs. 7A through 11B illustrate sequentially a method of recording SRR
15 according to the disc recording status in the write-once optical disc of the present invention. More specifically, FIGs. 7A through 11B show sequentially how the different types of SRRs (shown in FIGs. 2A through 3E) on the disc are created and how to record the SRR using the sequential steps performed according a time flow. These methods are implemented on
20 the write-once optical disc such as BD-WO having the SRR, the SRR and the disc structure as discussed herein in connection with FIGs. 1-6C.

FIG. 7A shows Step 1 in which the entire area of the disc is recordable as an initial black disc and a portion designated by a thick arrow indicates the NWA location. The start location of the disc is the NWA. Herein, only one SRR (SRR #1) exists on the disc. This is the invisible SRR shown in FIG. 2A.

5 Accordingly, a session is in the initial state of the disc wherein only one opened session #1 exists. The disc is a blank disc and the SRR is not yet recorded on the disc. A session is an upper-level recording-unit compared to the lower-level recording-unit such as an SRR, and includes at least one SRR. A plurality of sessions can be recorded on the disc and such a disc is
10 called a multi-session disc.

FIG. 7B shows Step 2 in which data (e.g., user data) are partially recorded on the blank disc of FIG. 7A, but the session #1 is not yet closed. Herein, only one SRR (SRR #1) exists on the disc, which is the incomplete SRR shown in FIG. 2B. The session #1 is maintained as the opened session. As
15 shown in FIG. 7B, the user data is recorded in a portion of the incomplete SRR #1 and an unrecorded portion (e.g., sector(s)) of the SRR #1 (cluster) is padded with dummy data. As described above, the padded sector of the SRR is indicated with "Padding_flag = 1b" which is recorded in a designated area of the cluster, e.g., within the padded sector of the cluster/SRR #1.

20 FIG. 7C illustrates a process of recording an SRR in the management area of the disc when the disc is in the state of FIG. 7B. For the convenience of

explanation, only certain portions among all the different components of the disc structure and SRRI structure shown in FIGs. 1 and 5 are shown. For instance, although the (SRRI + TDDS) or (TDFL + TDDS) are recorded in each cluster of the TDMA such as the TDMA0 of the disc as discussed above, only the SRRI is shown in the TDMA0 of FIG. 7C, and the TDFL and/or TDDS is omitted for the sake of clarity. Further, only the "List of opened SRRs" field 52 and the "List of SRR entries" field 30 among the different fields of the SRRI shown in FIG. 5 are shown.

The disc recording status of FIG. 7C is the case where only one opened SRR (SRR #1) is present in all the disc area as in FIG. 7B. As shown in FIG. 7C, when the incomplete SRR #1 is formed without closing the session as in FIG. 7B, the SRRI #1 (60a) pertaining to the SRR #1 is generated and recorded in the TDMA0. In the SRRI #1 (60a), the SRR number (SRR #1) of the opened SRR #1 is recorded in its "List of opened SRRs" field 52a. In the "List of SRR entries" field 30a of the SRRI #1 (60a), only one SRR entry 35a pertaining to the SRR #1 is present. The SRR entry 35a (or SRR entries 35b-35p discussed later) has the SRR entry structure of FIGs. 6A and 6B discussed above.

In the SRR entry 35a, since some portions of the SRR #1 are padded finally, the P_flag is set to "1b" as the status information of the corresponding SRR #1. Since the SRR #1 is the start SRR of the opened session #1, the S_flag

is set to "1b" as the status information of the corresponding SRR #1.

FIG. 8A shows Step 3 in which a session close command is received and executed at Step 2 of FIG. 7B. In response to the session close command, the area on which user data is recorded is separated into an independent
5 closed SRR and a new session is created at the area following the user data recorded area. For instance, as shown in FIG. 8A, the portion of the area that is recorded fully with the user data at Step 2 becomes the complete SRR #1 (closed SRR) which in turn forms the closed session #1. In addition, the unrecorded area becomes an invisible SRR #2 (opened SRR) which in
10 turn forms an opened session #2 at the same time.

FIG. 8B illustrates a process of recording the disc recording status (SRRI) as it pertains to the disc state as of FIG. 8A. Since the SRRI is a second recorded SRRI, this SRRI is named SRRI #2 (60b). The SRRI #2 (60b) is recorded next to the SRRI #1 (60a) in the TDMA0. For recording the status
15 of the disc of FIG. 8A, since the entire area of the disc has only one opened SRR (SRR #2) and only one closed SRR (SRR #1), the SRR number of the opened SRR #2 is recorded in the "List of opened SRRs" field 52b of the SRRI #2, and information on the SRRs #1 and #2 is recorded in the "List of SRR entries" field 30b of the SRRI #2 respectively as SRR entries 35b and 35c.
20 The SRR entry (e.g., 35b) shadowed in FIG. 8B (and in other figures) indicates that it is a closed SRR entry. Accordingly, since user data is not

yet recorded in the newly created SRR #2, the P_flag of the SRR #2 entry (35c) is set to "0b". Since the SRR #2 is the start SRR of the opened session #2, the S_flag of the SRR #2 entry (35c) is set to "1b".

FIG. 9A shows Step 4 in which two opened SRRs are additionally reserved to
5 newly record data when the disc is in the state of FIG. 8A. Accordingly, the newly created opened SRRs are opened empty SRRs #2 and #3 and have NWAs indicated by thick arrows. As a result, the opened session #2 is composed of the empty SRRs #2 and #3 and an invisible SRR #4.

FIG. 9B illustrates a process of recording the disc recording status (SRRI) as
10 it pertains to the disc state as of FIG. 9A. Since the SRRI is a third recorded SRRI, the SRRI is named SRRI #3 (60c). The SRRI #3 (60c) is recorded adjacent to the SRRI #2 (60b) in the TDMA0. For recording the status of the disc of FIG. 9A, since the entire area of the disc has three opened SRRs (SRRs #2, #3 and #4) and one closed SRR (SRR #1), the SRR numbers (SRRs
15 #2, #3 and #4) of the opened SRRs are recorded in the "List of opened SRRs" field 52c of the SRRI #3. Information on all four SRRs (SRRs #1 - #4) is recorded in the "List of SRR entries" field 30c of the SRRI #3 respectively as SRR entries 35d-35g.

Accordingly, since information on the newly created SRR #2, #3 and #4 is
20 recorded in the SRRI #3 (60c) and user data is not yet recorded on the SRRs #2, #3 and #4, the P_flags of the corresponding SRR entries 35e, 35f, 35g

are set to "1b". However, since the SRRs #3 and #4 are not the start SRR of the opened session #2, but the SRR #2 is the session start SRR, the S_flags of the SRR #2 entry 35e, the SRR #3 entry 35f and the SRR #4 entry 35g are set respectively to "1b", "0b" and "0b".

5 FIG. 10A shows Step 5 in which user data is recorded in the empty SRR #2 and in the invisible SRR #4 of FIG. 9A. Accordingly, the first empty SRR #2 is changed into a partially recorded SRR #2, and the invisible SRR #4 is changed into an incomplete SRR #4, but the opened empty SRR #3 is not changed. The SRR #2 is recorded with user data without padding. The SRR
10 #4 is recorded with user data and is also padded with padding data. In the padded sector of the SRR #4, the Padding_flag is set to "1b".

FIG. 10B illustrates a process of recording the disc recording status (SRRI) as it pertains to the disc state as of FIG. 10A. Since the SRRI is a fourth recorded SRRI, the SRRI is named SRRI #4 (60d). The SRRI #4 (60d) is
15 recorded next to the SRRI #3 (60c). For recording the status of the disc of FIG. 10A, since the entire area of the disc has three opened SRRs (SRRs #2 - #4) and one closed SRR (SRR #1), the SRR numbers of the opened SRRs (SRRs #2 - #4) are recorded in the "List of opened SRRs" field 52d of the SRRI #4 (60d). Information on all four SRRs (SRRs #1 - #4) is recorded in
20 the "List of SRR entries" field 30d of the SRRI #4 (60d) respectively as SRR entries 35h-35k.

At this step, the number of the SRR entries and the location of the opened SRRs are the same as those shown in FIG 9B, but since user data is recorded on a specific opened SRR, the LRA of the recorded opened SRR entry is changed and the value of the P_flag is also changed. In other words, information on the recorded SRRs #2 and #4 is updated. Since the SRR #2 is recorded with user data without padding, the P_flag of the SRR #2 entry 35i is maintained to be "0b". Since the SRR #4 is recorded with user data and is padded, the P_flag of the SRR #4 entry 35k is changed to be "1b".

FIG. 11A shows Step 6 in which a session close command is received and executed when the disc is in the state of FIG. 10A. As shown in FIG. 11A, the additionally recordable portion of the opened SRR or a part of the additionally recordable portion of the opened SRR is padded with dummy data before the opened SRR is closed. As described above, the padding operation is an optional feature. In addition, when the padding is performed, specific data (for example, "CLSD" as character code) may be recordable as the padding data as described above.

The SRRs #2, #3 and #4 that were previously opened SRRs are changed into a closed partially recorded SRR #2, a closed empty SRR #3 and a complete SRR #4, which in turn form the closed session #2. In the SRRs #2 and #3, an additionally recordable area remains but is changed into a closed SRR by a close command. Herein, some portion is alternatively padded with dummy

data. Accordingly, all the sectors in the cluster/SRR (e.g. FIG. 4B) padded with dummy data are set with `Padding_flag = 1b`. However, even in this case, LRA recorded in the SRR entry means an end location where the user data are actually recorded. Dummy data portion does not affect the
5 determination of the LRA location as described above. A remaining outermost SRR #5 is an invisible SRR #5, which in turn forms a new opened session #3.

FIG. 11B illustrates a process of recording the disc recording status (SRRI) as it pertains to the disc state as of FIG. 11A. Since the SRRI is a fifth
10 recorded SRRI in the management area, the SRRI is named SRRI #5 (60e). The SRRI #5 (60e) is recorded next to the SRRI #5 (60d) in the TDMA0. For recording the status of the disc of FIG. 11A, since the entire area of the disc has one opened SRR (SRR #5) and four closed SRRs (SRRs #1 - #4), the SRR number of the opened SRR (SRR #5) is recorded in the "List of opened SRRs"
15 field 52e of the SRRI #5, and all the previous opened SRR numbers (for example, SRRs #2, #3 and #4 in FIG. 10B) recorded in the SRRI #4 are removed from the current opened SRR list 52e. Removal of the SRRs from the "List of opened SRRs" field means that such SRRs are closed. Information on all five SRRs (SRRs #1 - #5) is recorded in the "List of SRR
20 entries" field 30e of the SRRI #5 respectively as SRR entries 351-35p.

Since the SRRs #2 and #3 are padded with dummy data in response to the

close command, the P_flag of the SRR #2 entry 35m and the SRR #3 entry 35n are changed to "1b" to indicate that at least a part of the corresponding SRR is padded with padding data. Since the LRA of an SRR entry is an end location where the user data is actually recorded, the LRAs of the SRRs #2 -
5 #4 have the same value as the previous LRAs recorded in the SRR #4 (60d). In addition, since user data is not yet recorded on the newly created invisible SRR #5, the P_flag of the SRR #5 entry 35p is set to be "0b". Since the SRR #5 is a start SRR of the new session #3, the S_flag of the SRR #5 entry 35p is set to be "1b".

10 As can be seen through FIGs. 7A to 11B, SRR #5 is the information indicating the recording status of the current disc. When loading the optical disc of the present invention into the recording/playback apparatus, the recording/playback apparatus should check the latest SRR #5 (SRR #5, in the above example) finally recorded in the
15 management area. Since only the latest SRR #5 correctly indicates the final recording status of the disc, it is possible to check the location of the additionally recorded SRR.

However, when the power is suddenly turned off while using the disc or the disc is damaged, the latest SRR #5 of the disc may not be read out
20 correctly. At this time, the final recording status need to be reconstructed using the latest SRR #5 among the non-damaged SRRs.

According to the present invention, the SRR is padded in the padding operation when the SRR is to be closed, and this padding information can be used to reconstruct the final recording status of the disc even when the latest SRRI on the disc is at a damaged condition. Through
5 it, it is possible to recover the latest SRRI and the current recording status of the disc.

FIGs. 12, 13A and 13B illustrate a method of recording data on a write-once optical disc according to the present invention. This method estimates the final recording status of the disc, recovers the
10 latest SRRI of the disc even when the latest SRRI is damaged. The recording/playing back can be performed using the final recording status obtained from the latest SRRI.

When the corresponding SRRI is judged as a defective area and the recorded information is not reliable, the SRRI is said to be damaged.

15 If the latest SRRI is damaged, it means that the final recording status of the disc cannot be obtained from the latest SRRI. Therefore, the recordable location of the disc cannot be known. In the worst case, the disc itself cannot be used any more.

The present invention provides the method of correctly recovering the
20 final recording status of the disc when the latest SRRI is damaged.

Particularly, FIG. 12 is a flowchart illustrating a method of recovering

the final recording status of a write-once optical disc such as a BD-WO and performing the recording/playback operation on the disc according to an embodiment of the present invention. The disc contains the disc structure and the SRRI structure as discussed above.

5 Referring to FIG. 12, if the disc is loaded in an optical recording/playback apparatus such one shown in FIG. 14, the latest SRRI recorded within the management area (e.g., the TDMA0) is read out. Then, it is checked whether or not the read SRRI is damaged (S10).

10 If the latest SRRI is not damaged, the final disc recording status is obtained from the latest SRRI (S21). Then using the latest SRRI, the recording is performed to only the additionally recordable area and/or the playback operation is performed to the already recorded area (S22). The information on such areas is obtained from the latest SRRI.

15 On the other hand, if the step S10 determines that the latest SRRI is damaged, the latest SRRI among the non-damaged SRRI(s) is determined (S31). Then this latest non-damaged SRRI is read out (S32). The damaged SRRI can be recovered using the latest non-damaged SRRI and the actual recording status of the disc (S33). Step
20 S33 may be an optional step. The recording is performed to the additionally recorded area and/or the playback operation is performed

to the already recorded area (S34). Information on such areas can be determined from the latest non-damaged SRRI and/or the actual recording status of the disc. After the recording/playback step S34, the newly changed recording status may be recorded as a new SRRI in the management area.

FIGs. 13A and 13B illustrates an example of the step S33 in FIG. 12 of recovering the final recording status when the latest SRRI (SRRI #5 in the example of FIG. 11B) is damaged. For the convenience of explanation, the SRRI recording method of FIGs. 7A to 11B will be described as an example.

As shown in FIG. 13A, if the SRRIs are in the normal status, the SRRI #5 (60e) becomes the latest SRRI of the disc. However, if the SRRI #5 is damaged, the recording/playback apparatus reads the latest SRRI among the non-damaged SRRIs. In the example, the SRRI #4 (60d) is the latest SRRI among the non-damaged SRRIs #1 - #4.

The actual recording status associated with Step 6 in FIG. 11A can be determined from the SRRI #5 (60e) which is written as indicated in FIG. 11B. However, since the SRRI #5 (60e) is damaged, the latest SRR information that can be checked by the recording/playback apparatus is the SRRI #4 (60d). But the SRRI #4 does not necessarily carry the final recording status of the disc since the SRRI #5 carries

this information. Then, in order to recover the final recording status of the disc without using the SRR I #5, the SRR I #4 and the actual final recording status of the disc need to be compared. This can be accomplished as follows.

5 The recording/playback apparatus (e.g., FIG. 14) checks the location of the opened SRR(s) and the associated LRA information from the SRR I #4. In the example of FIG. 13A, it is determined from the "List of opened SRRs" field 52d of the SRR I #4 (60d) that there are three opened SRRs #2, #3 and #4. Then by accessing the LRA field of these

10 SRR entries corresponding to these opened SRRs from the "List of SRR entries" field 30d of the SRR I #4 (60d), the LRAs are obtained and used to verify whether the corresponding SRR is truly an opened SRR. In this regard, only the opened SRR(s) identified in the field 52d of the SRR I #4 (60d) are examined. The location recorded with the closed

15 SRR(s) may not be verified. Once an opened SRR is changed to a closed SRR, the closed SRR cannot be changed back to an opened SRR. As a result, the recovery of the final SRR information is possible by checking whether each of the opened SRR(s) is changed to the closed SRR.

20 In the case of the SRRs #2 and #3 that are identified as the opened SRRs in the field 52d of the SRR I #4 (60d), each of the SRRs #2 and

#3 is examined to determine whether or not predetermined padding data (e.g., dummy data) are recorded after its LRA (identified in the LRA field of the entry), as can be seen from FIG. 11A (actual final disc recording status). If the padding is detected, then the recording/playback apparatus determines that the corresponding opened SRR is changed to a closed SRR.

In the case of the SRR #4 that is recognized as the opened SRR from the field 52d of the SRRI #4, the recording/playback apparatus examines the SRR #4 to determine whether or not the padding data (e.g., dummy data) are presented after its LRA location in FIG. 11A (actual final disc recording status). The SRR #4 can be analyzed as the opened SRR in the actual final disc recording status. Also, it can be seen that an area after the LRA location of the SRR #4 is recordable, i.e., this area is the NWA. Then in the recording/playback apparatus, the already recorded area of the original SRR #4 is determined to a closed SRR (new closed SRR #4) and only the recordable area of the original SRR #4 is analyzed as the opened SRR (new SRR #5). Thus the contents of the damaged SRRI #5 can be reconstructed by using the above analysis results. Moreover, since the information necessary to perform the recording operation by the recording/playback apparatus is the additionally recordable position information (NWA),

the NWA location in association with the old and new SRR #4 is not changed and thus can be used by the recording/playback apparatus.

FIG. 13B illustrates a result of the recovery of the latest SRRI #5 by the process of FIG. 13A as discussed above. This result accords with

5 the final recording status of the actual disc. Accordingly, the recording/playback apparatus again records the selectively recovered

latest SRRI #5 within the management area (at this time, as the SRRI #6 (60f), or performs the recording to only the additionally recordable

10 area. The SRRI #6 (60f) includes the "List of opened SRRs" field 52f identifying the SRR #5, and the "List of SRR entries" field 30f

containing SRR entries 35q-35u corresponding respectively to the SRRs #1 - #5. Also, even if the recovered SRRI #5 is not recorded as

the SRRI #6, data recording is performed from the recovered NWA information and the recording status as changed by the data

15 recording to the recovered NWA is recorded as a new SRRI #6.

FIG. 14 illustrates an optical disc recording/playback apparatus according to the present invention. This apparatus or other suitable

apparatus or system can be used to implement the disc and/or SRRI structures and methods of the present invention discussed herein.

20 Referring to FIG. 14, the optical disc recording/playback apparatus includes a recording/playback unit 10 for recording and/or

reproducing data to/from the optical disc and a controller 20 for controlling the recording/playback unit 10. All the elements of the recording/playback apparatus are operatively coupled. The controller 20 transmits a command for recording and/or reproducing to/from a special recording area such as an SRR/session on the disc, to the recording/playback unit 10. The recording/playback unit 10 records and/or reproduces data to/from the disc according to the commands of the controller 20.

Industrial Applicability

The recording/playback unit 10 includes an interface unit 12, a pick-up unit 11, a data processor 13, a servo unit 14, a memory 15 and a microcomputer 16. The interface unit 12 communicates with external devices such as the controller 20. The pick-up unit 11 records or reproduces data to/from the optical disc directly. The data processor 13 receives a reproduction signal from the pick-up unit 11, restores a preferred signal, modulates a signal proper to the optical disc, and transmits the signal. The servo unit 14 controls the pick-up unit 11 to read the signal from the optical disc or to record the signal to the optical disc. The memory 15 stores temporarily data and various information including management information as discussed herein.

The microcomputer 16 controls the components of the recording/playback unit 10. Since the recording/playback apparatus shown in FIG. 14 can selectively perform a padding operation, a designer can more freely design the recording/playback apparatus.

5 The recording/playback unit 10 can automatically store specific data during a padding operation.

The method of recording and playing back data on an optical disc is classified into two kinds. The first one is the case of FIGs. 4A through 11B, which involves the method of completely recording data on an opened SRR, forcedly padding the remaining sector(s) in the cluster including the LRA, and recording information identifying whether or not padding has been performed to the remaining sector(s), or determining whether or not to pad the cluster and recording padding identification information according to the padding when closing an SRR.

10

15

The second one is the method of effectively recovering a damaged SRR using the padding information of FIGs. 12-13B. When closing an SRR, padding the SRR is optionally performed. However, if the padding is performed to the SRR and then the SRR is closed, then this padding information can be used advantageously to recover data.

20

The first recording/playback method of the optical disc according to an embodiment of the present invention will be described in detail. When the optical disc such as a BD-WO is loaded into the recording/playback apparatus such as the one shown in FIG. 12, the latest SRR is read as the latest disc management information recorded in a TDMA. Furthermore, the SRR header and the SRR entry(ies) recorded in the latest SRR are read and temporarily stored in the memory 15 of the recording/playback unit 10.

The stored SRR represents the latest disc recording status. The opened SRR(s) can be identified through the SRR header information. Through the SRR entry(ies), data can be recorded in the entire area of the disc or the existence and location of the non-recording status and opened session can be checked. Also, it can be identified whether or not the SRR has been padded with padding data. All such information can be used when the optical disc is recorded and played back.

Then, data (e.g., user data) is recorded on a specific opened SRR. When the data is completely recorded in the opened SRR, the unrecorded sector(s) in the cluster including the LRA is padded with dummy data (e.g., for stability and robust reasons) and the padding identification information `Padding_flag` is set to "1b". For

each of the padded sectors, Padding_flag corresponding to each sector is set to "1b". If the sector is not padded, then the corresponding Padding_flag is set to "0b". Also, when the SRR entry in the SRRI is updated, the SRR status information P_flag is set to "1b" to indicate that the corresponding SRR has at least some part that is padded.

Additionally, even in the case where the SRR is closed by a close command of the controller 20, the microcomputer 16 can select whether a recordable area (for example, one cluster) closed after padding or without padding. In the above case, a designer can design so that the recording/playback unit 10 automatically pads the SRR with padding data and closes the SRR unconditionally without a padding command from the controller 20. The above function is called "automatic padding function" by the recording/playback unit 10. The automatic padding function is more advantageous to reduce padding operation time, compared to the case where the recording/playback unit 10 receives dummy data by a padding command and pads the SRR thereafter.

In addition, if the SRR status is changed by padding as described above, the Padding_flag is set to 1b according to each padded sector. Furthermore, the P_flag is set to 1b in the corresponding

SRR entry. Different recording/playback apparatuses can use such information.

Accordingly, the types and definitions of the SRRs as defined by the present invention and a method of recording the SRRI according to the defined SRR types and definitions, are provided.

Accordingly, various recording/playback apparatuses having desired functions can be used to access the present disc.

In addition, the second method for recording and playing back data by recovering the optical disc will be described. When an optical disc is loaded into the recording/playback apparatus, the microcomputer 16 controls the pickup unit 11 to read the latest SRRI recorded in the set management area such as TDMA of the corresponding disc. The microcomputer 16 determines whether the latest SRRI is damaged. If it is determined that the latest SRRI is damaged, the latest SRRI is estimated and recovered from non-damaged SRRIs as described above referring to FIGs. 12, 13A and 13B. When the opened SRR is changed into the closed SRR by a close command, the dummy data with which the disc is padded is checked, so that the latest SRRI can be recovered as described above.

If the recovered latest SRRI or the original latest SRRI is not

damaged, the recording/playback unit 10 checks the location of the additionally recordable opened SRR based on the corresponding latest SRRI, records data, receives a close command of the controller 20, pads some portion (or entire area) of an additionally recordable area remaining in the opened SRR with dummy data, and represents that the SRR is changed to a closed SRR. The changed disc recording status is recorded as a new (latest) SRRI in a management area. After that, when the corresponding optical disc is loaded again, the final disc recording status can be exactly checked from the latest SRRI.

The method for recording management information of the write-once optical disc according to the present invention includes defining new SRR types and session types. If an open SRR is padded or if the SRR is closed by padding, padding identification information `Padding_flag` is set appropriately and recorded in the padded area. Other padding identification information `P_flag` is recorded in the SRR entry. Consequently, in the write-once optical disc having the new physical structure, the management information can be effectively recorded and managed. When the SRR is closed after padding, the padding information can be used to recover the damaged SRRI.

Claims

1. A method for recording management information on a recording medium including a sequential recording-unit composed of at least one basic recording-unit, the at least one basic recording-unit composed of a plurality of sectors, the method comprising:
5 recording user data sequentially from a writable location in the sequential recording-unit in the direction of increasing address;
padding, with padding data, remaining unrecorded sectors of a last
10 basic recording-unit when a last recorded location of the last basic recording-unit does not match with a boundary of the last basic recording-unit; and
recording padding identification information identifying which part of the at least one basic recording-unit is padded, the padding
15 identification information being composed of a plurality of padding flags, each of the padding flags pertaining to each of the sectors.
2. The method of claim 1, the method further comprising:
removing a sequential recording-unit identity from an opened
20 sequential recording-unit information when the sequential recording-

unit is closed.

3. The method of claim 2, the method further comprising:
padding, with the padding data, one or more basic recording-units
5 from the new writable location; and
recording the padding identification information to indicate that one
or more basic recording-units are padded.

4. The method of claim 1, wherein the writable location in the
10 sequential recording-unit is moved to a new writable location, the new
writable location being a first sector of an available adjacent basic
recording-unit.

5. A method for recording management information on a recording
15 medium including at least one recording-unit, the method comprising:
sequentially recording data in the at least one recording-unit in the
direction of increasing address;
padding, with padding data, a remaining non-recorded part of a last
recording-unit when terminating the sequential recording of the data;
20 and

recording padding identification information on the recording medium,
the padding identification information identifying which part of the at
least one recording-unit is padded.

5 6. The method of claim 5, wherein each recording-unit is a cluster,
and in the padding step, all remaining non-recorded sectors of the last
cluster are padded with the padding data.

10 7. The method of claim 6, wherein in the recording step, the
padding identification information includes a plurality of padding flags
each assigned to a sector of the cluster, and the padding flags are set
to a certain value depending on whether or not the assigned sector is
padded.

15 8. The method of claim 6, wherein in the padding step, the
padding occurs one sector at a time.

20 9. The method of claim 7, wherein each cluster is composed of 32
sectors, such that there are 32 padding flags corresponding
respectively to 32 sectors of the cluster.

10. The method of claim 5, wherein the padding identification information is recorded in a management area of the recording medium.

5

11. The method of claim 5, wherein in the padding step, the padding data is zero.

10

12. A method for recording management information on a recording medium including at least one sequential recording range (SRR), each SRR being composed of at least one cluster, the method comprising: recording user data in an SRR; and padding, with padding data, a remaining non-recorded area of a last cluster in the SRR when terminating the recording of the user data.

15

13. The method of claim 12, wherein in the padding step, the padding data is zero.

14. The method of claim 12, wherein in the padding step, all remaining non-recorded sectors of the last cluster are padded with the

20

padding data.

15. A recording medium comprising:

a sequential recording-unit composed of at least one basic recording-
5 unit, the at least one basic recording-unit composed of a plurality of
sectors;

user data sequentially recorded from a writable location in the
sequential recording-unit in the direction of increasing address;

padding data recorded in remaining unrecorded sectors of a last basic
10 recording-unit when a last recorded location of the last basic
recording-unit does not match with a boundary of the last basic
recording-unit; and

padding identification information identifying which part of the at
least one basic recording-unit is padded, the padding identification
15 information being composed of a plurality of padding flags, each of the
padding flags pertaining to each of the sectors.

16. The recording medium of claim 15, further comprising:

padding data recorded in one or more basic recording-units from the
20 new writable location; and

padding identification information to indicate that the one or more basic recording-units are padded.

17. The recording medium of claim 15, wherein the writable location
5 in the sequential recording-unit is moved to a new writable location, the new writable location being a first sector of an available adjacent basic recording-unit.

18. A recording medium comprising:

10 at least one recording-unit;

data recorded sequentially in the at least one recording-unit in the direction of increasing address;

padding data recorded in a remaining non-recorded part of a last recording-unit when terminating the sequential recording of the data;

15 and

padding identification information recorded on the recording medium, the padding identification information identifying which part of the at least one recording-unit is padded.

19. The recording medium of claim 18, wherein each recording-unit

20

is a cluster, and all remaining non-recorded sectors of the last cluster are padded with the padding data.

20. The recording medium of claim 19, wherein the padding
5 identification information includes a plurality of padding flags each assigned to a sector of the cluster, and the padding flags are set to a certain value depending on whether or not the assigned sector is padded.

10 21. The recording medium of claim 19, wherein the padding occurs one sector at a time.

22. The recording medium of claim 19, wherein each cluster is
15 composed of 32 sectors, such that there are 32 padding flags corresponding respectively to 32 sectors of the cluster.

23. The recording medium of claim 18, wherein the padding
identification information is recorded in a management area of the
recording medium.

20

24. The recording medium of claim 18, wherein the padding data is zero.

25. A recording medium comprising:

5 at least one sequential recording range (SRR), each SRR being composed of at least one cluster;

user data recorded in a particular SRR among the at least one SRR;

and

padding data recorded in a remaining non-recorded area of a last
10 cluster in the particular SRR when terminating the recording of the user data.

26. The recording medium of claim 25, wherein the padding data is zero.

15

27. The recording medium of claim 25, wherein all remaining non-recorded sectors of the last cluster are padded with the padding data.

20 28. An apparatus for recording management information on a

recording medium including a sequential recording-unit composed of at least one basic recording-unit, the at least one basic recording-unit composed of a plurality of sectors, the apparatus comprising:

a recording/reproducing part to record user data sequentially from a writable location in the sequential recording-unit in the direction of increasing address; to pad, with padding data, remaining unrecorded sectors of a last basic recording-unit when a last recorded location of the last basic recording-unit does not match with a boundary of the last basic recording-unit; and to record padding identification information identifying which part of the at least one basic recording-unit is padded, the padding identification information being composed of a plurality of padding flags, each of the padding flags pertaining to each of the sectors.

29. The apparatus of claim 28, wherein the writable location in the sequential recording-unit is moved to a new writable location, the new writable location being a first sector of an available adjacent basic recording-unit.

30. An apparatus for recording management information on a

recording medium including at least one recording-unit, the apparatus comprising:

a recording/reproducing part to sequentially record data in the at least one recording-unit in the direction of increasing address; to pad
5 with padding data a remaining non-recorded part of a last recording-unit when terminating the sequential recording of the data; and to record padding identification information on the recording medium, the padding identification information identifying which part of the at least one recording-unit is padded.

10

31. An apparatus for recording management information on a recording medium including at least one sequential recording range (SRR), each SRR being composed of at least one cluster, the apparatus comprising:

15 a recording/reproducing part to record user data in an SRR, and to pad with padding data a remaining non-recorded area of a last cluster in the SRR when terminating the recording of the user data.

FIG. 1

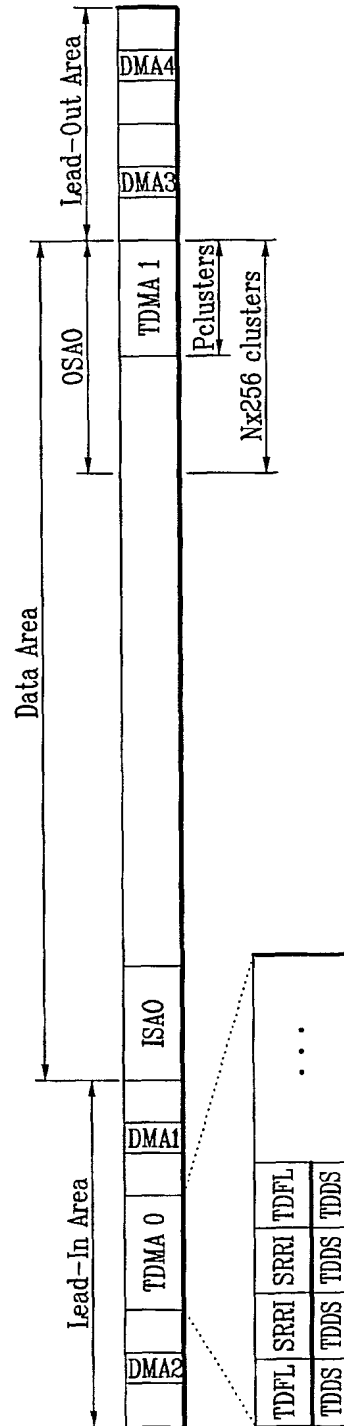

- * DMA : Disc Management Area
- * TDMA : Temporary DMA
- * ISA : Inner Spare Area
- * OSA : Outer Spare Area
- * TDFL : Temporary Defect List
- * TDDS : Temporary Disc Definition Structure
- * SRR : Sequential Recording Range
- * SRR : SRR Information

FIG. 2B

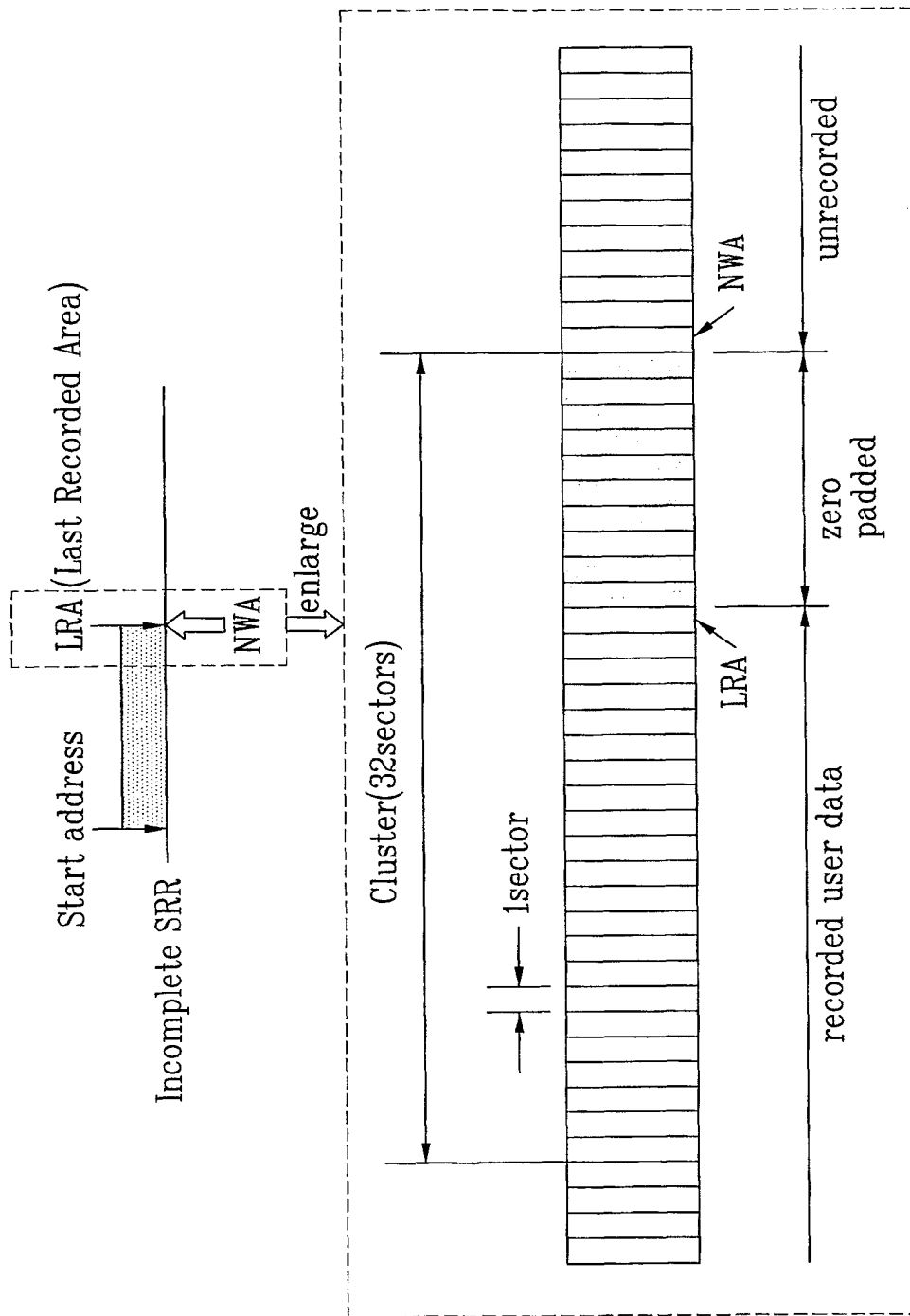

FIG. 2D

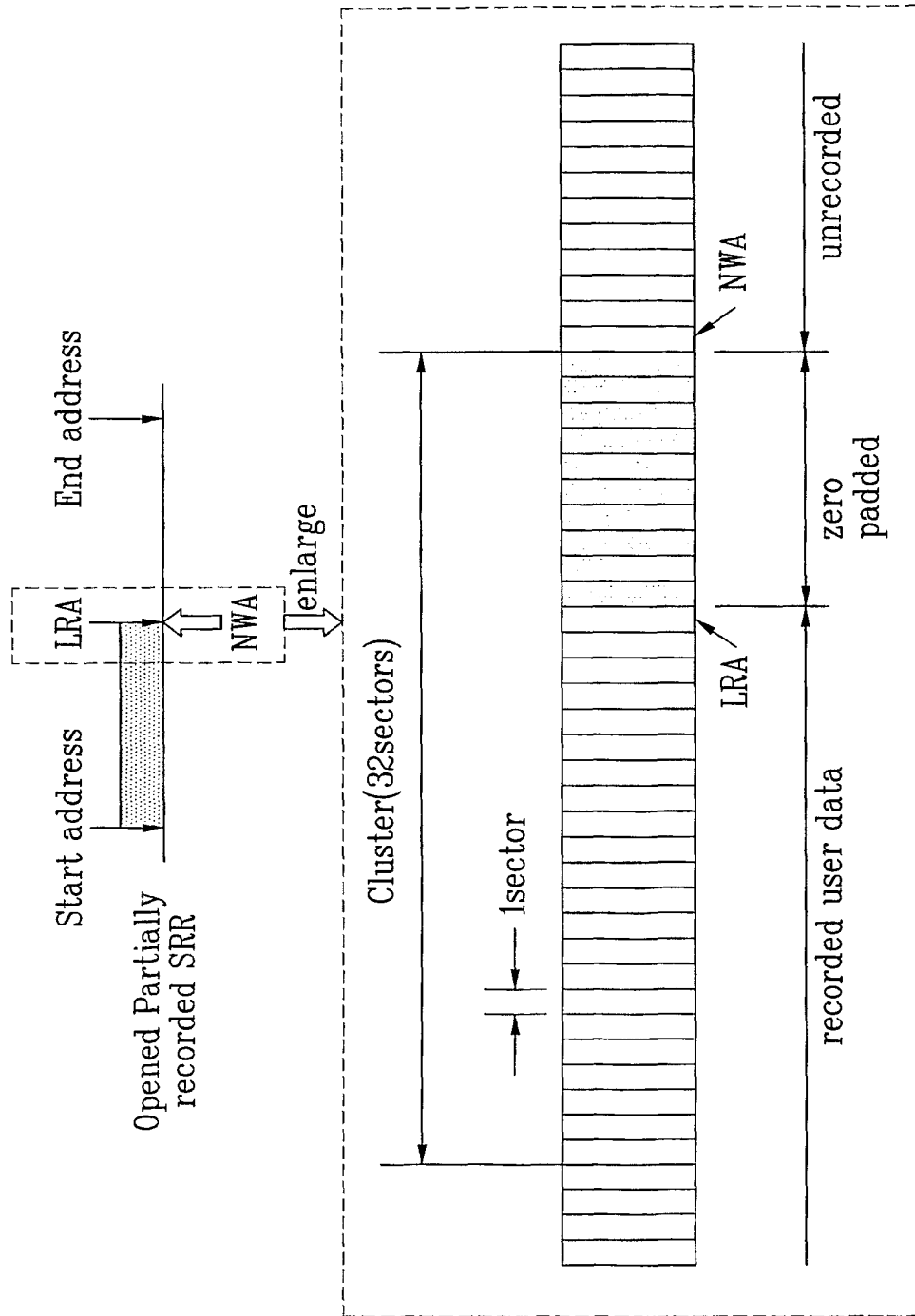

FIG. 4A

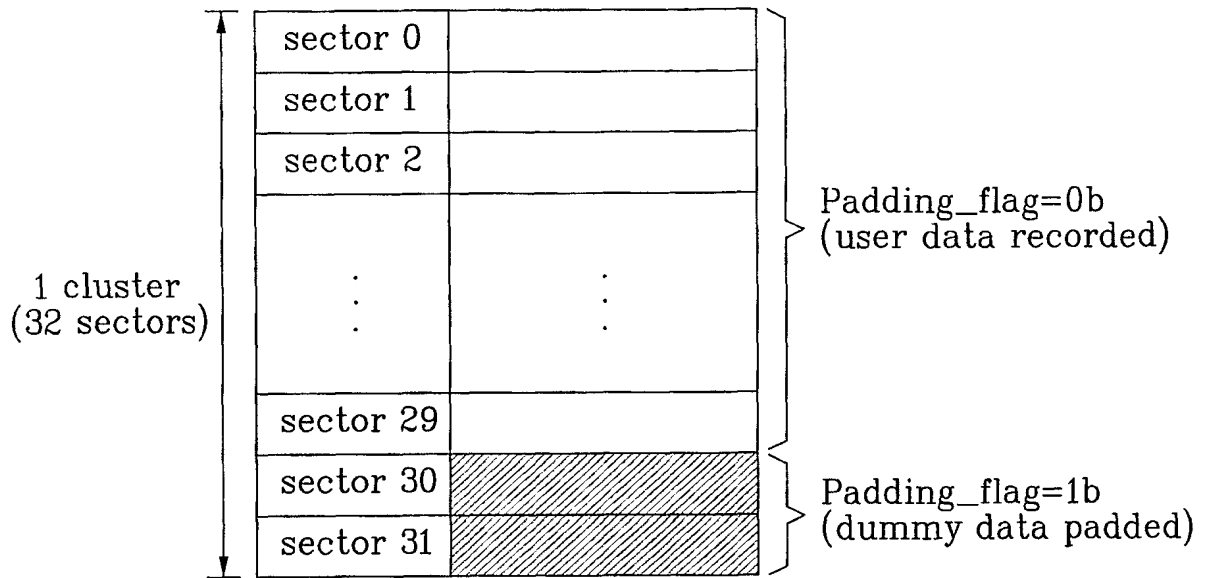

FIG. 4B

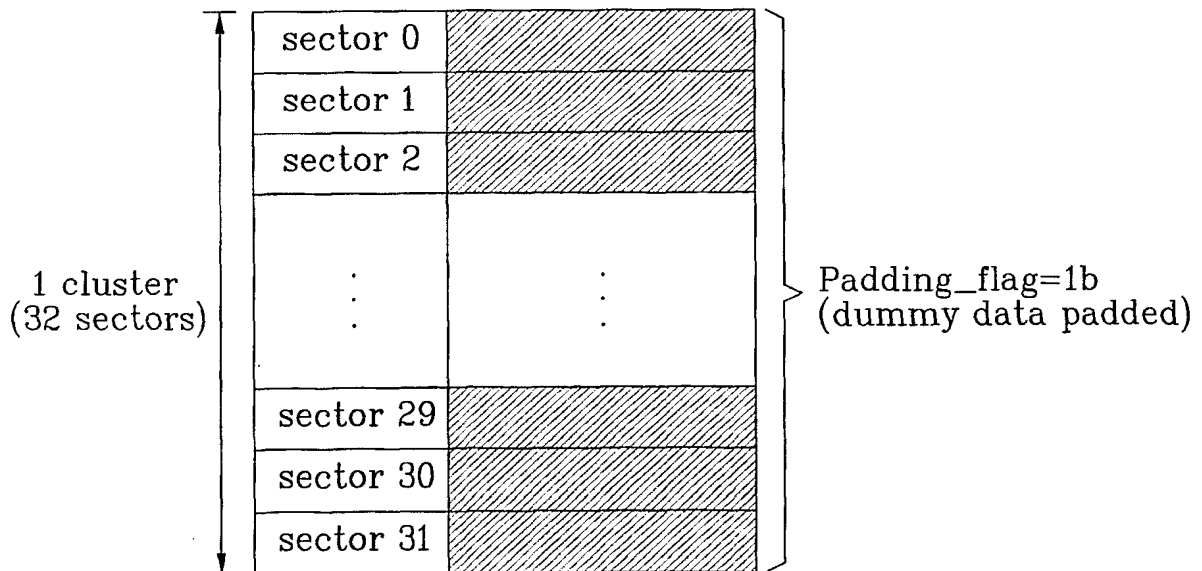
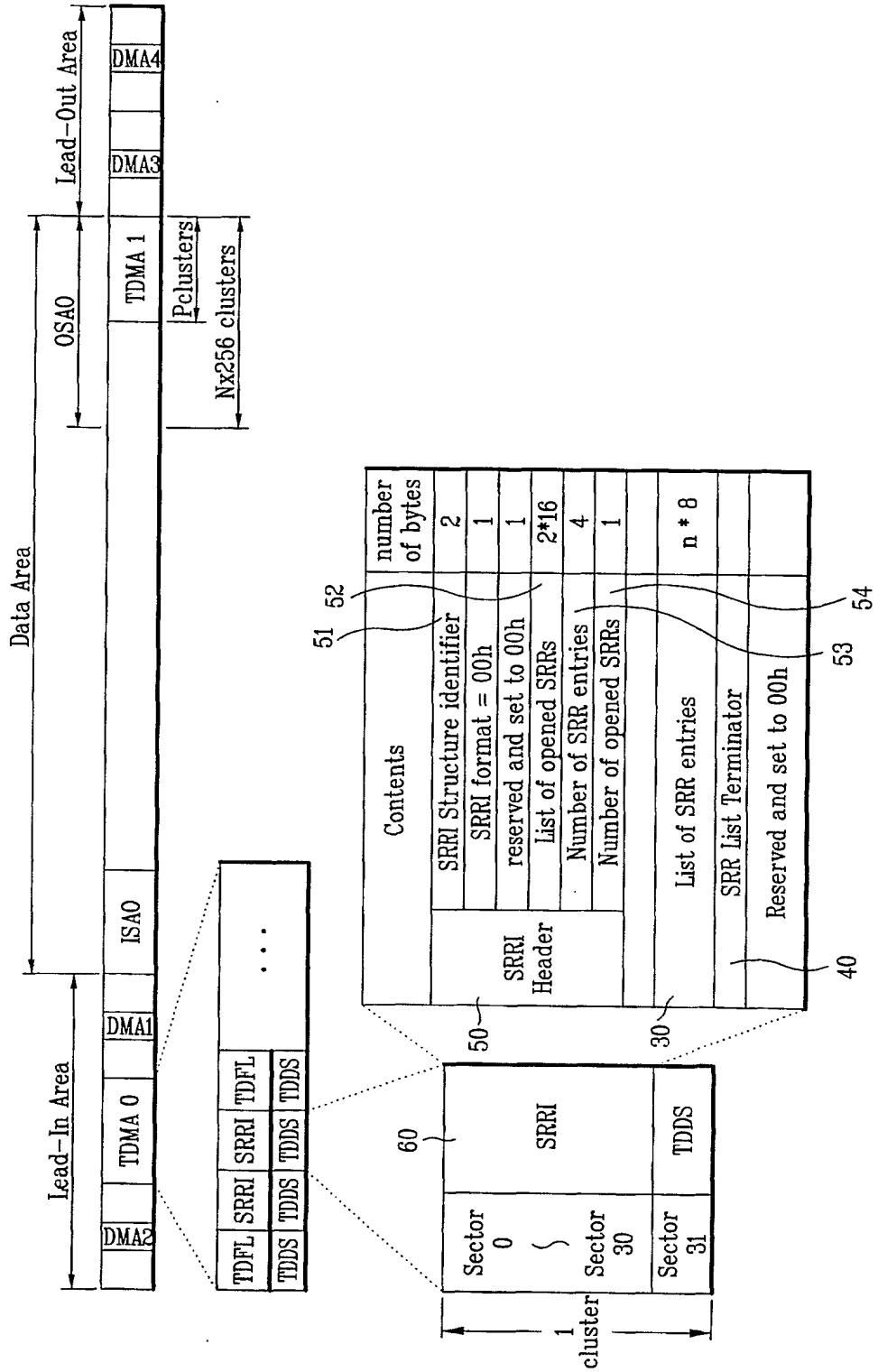

FIG. 5



9/25

FIG. 6A

List of SRR entries(30)

	32		33	
	b ₆₃ .. b ₆₀	b ₅₉ .. b ₃₂	b ₃₁ .. b ₂₈	b ₂₇ .. b ₀
31	status 1	Start address of SRR #n	status 2	LRA of SRR #n
	status 1	Start address of SRR #n+1	status 2	LRA of SRR #n+1
	status 1	Start address of SRR #n+2	status 2	LRA of SRR #n+2
	⋮	⋮	⋮	⋮

FIG. 6B

SRR entry(35)

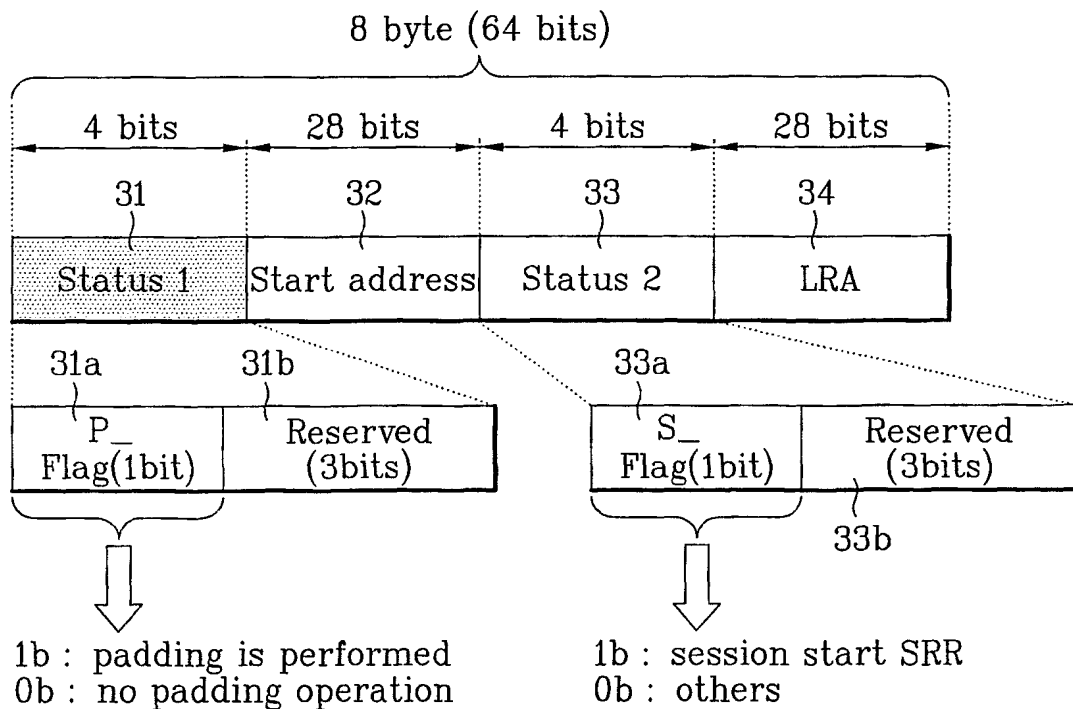

FIG. 7C

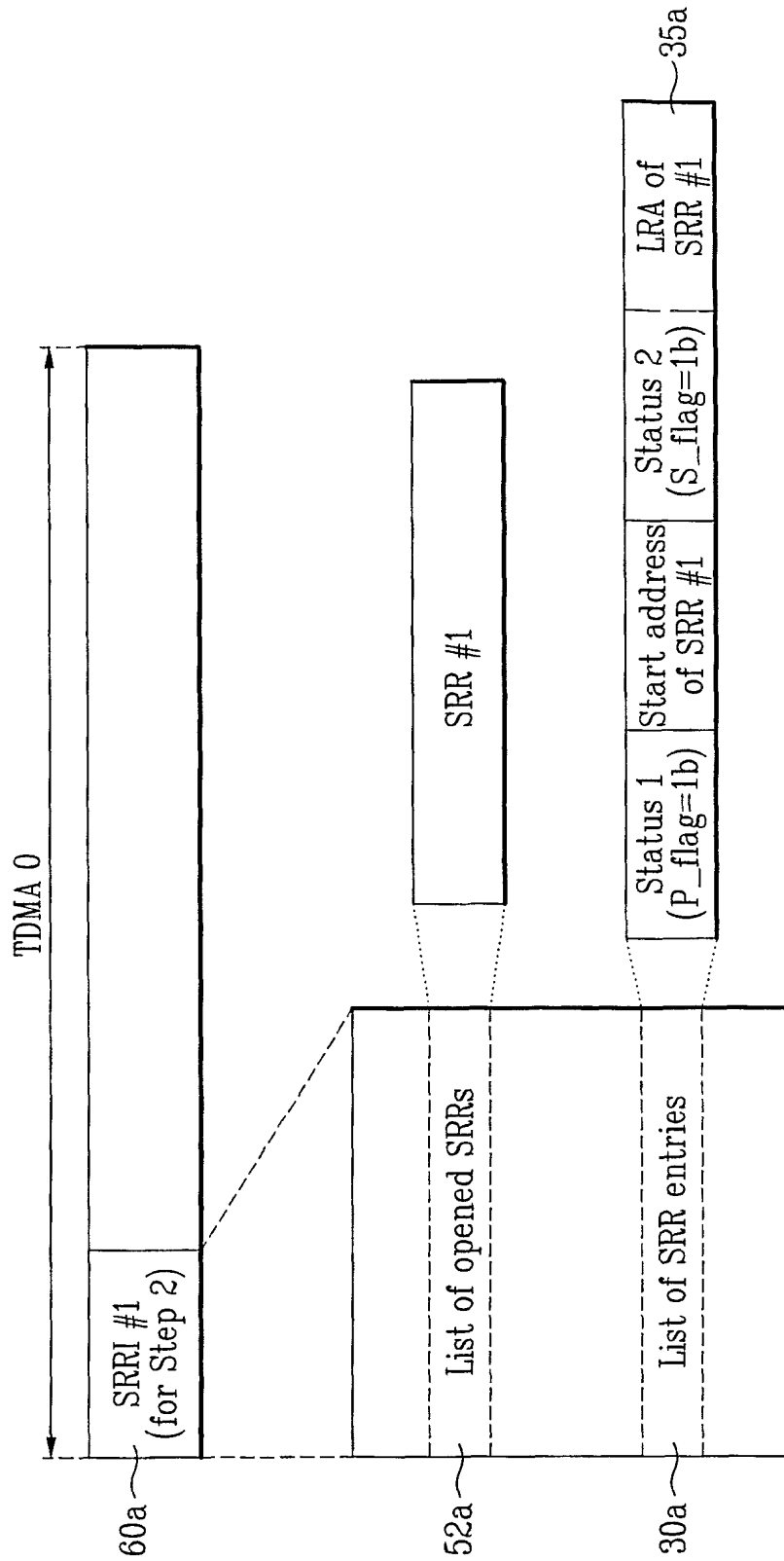

FIG. 8B

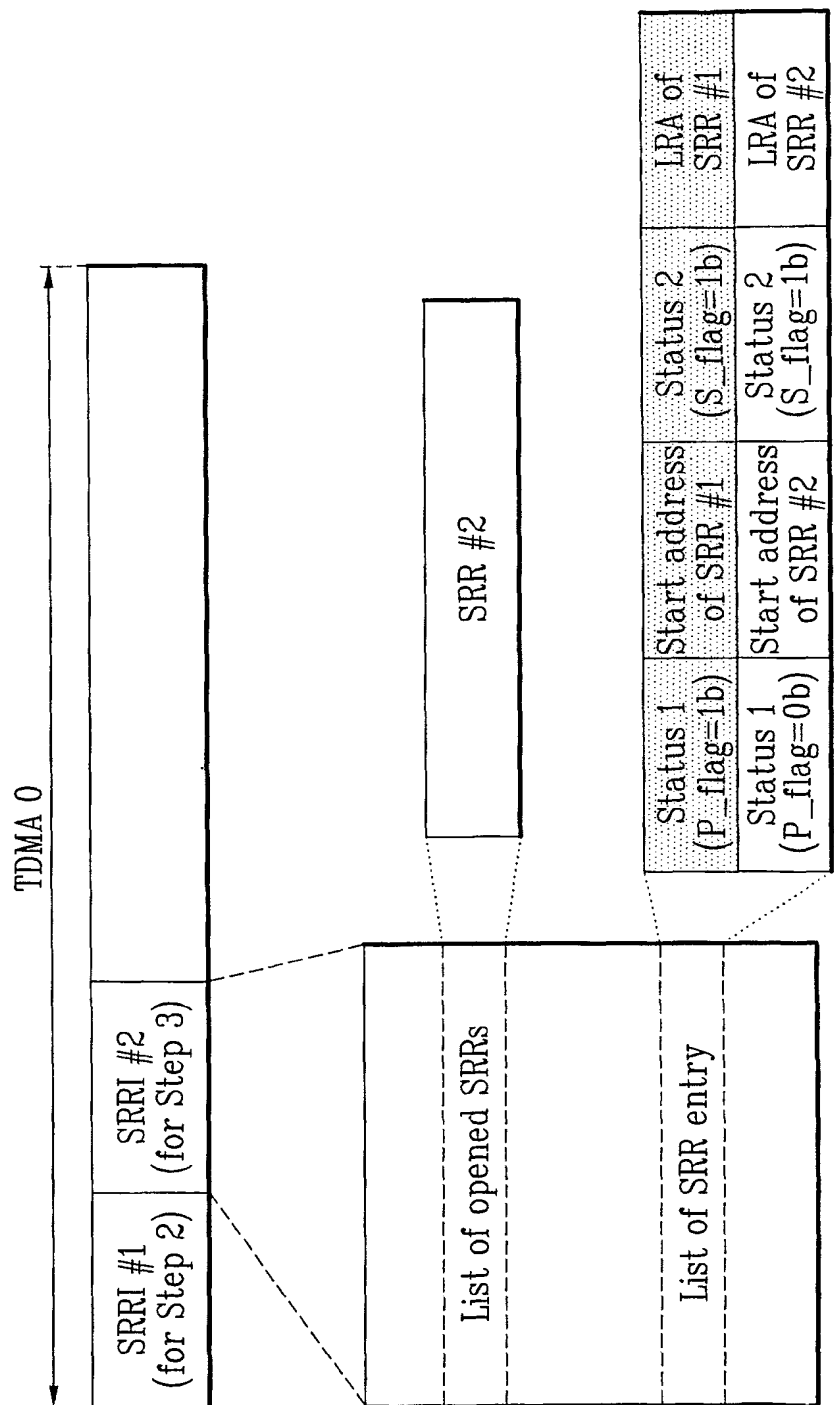

FIG. 9B

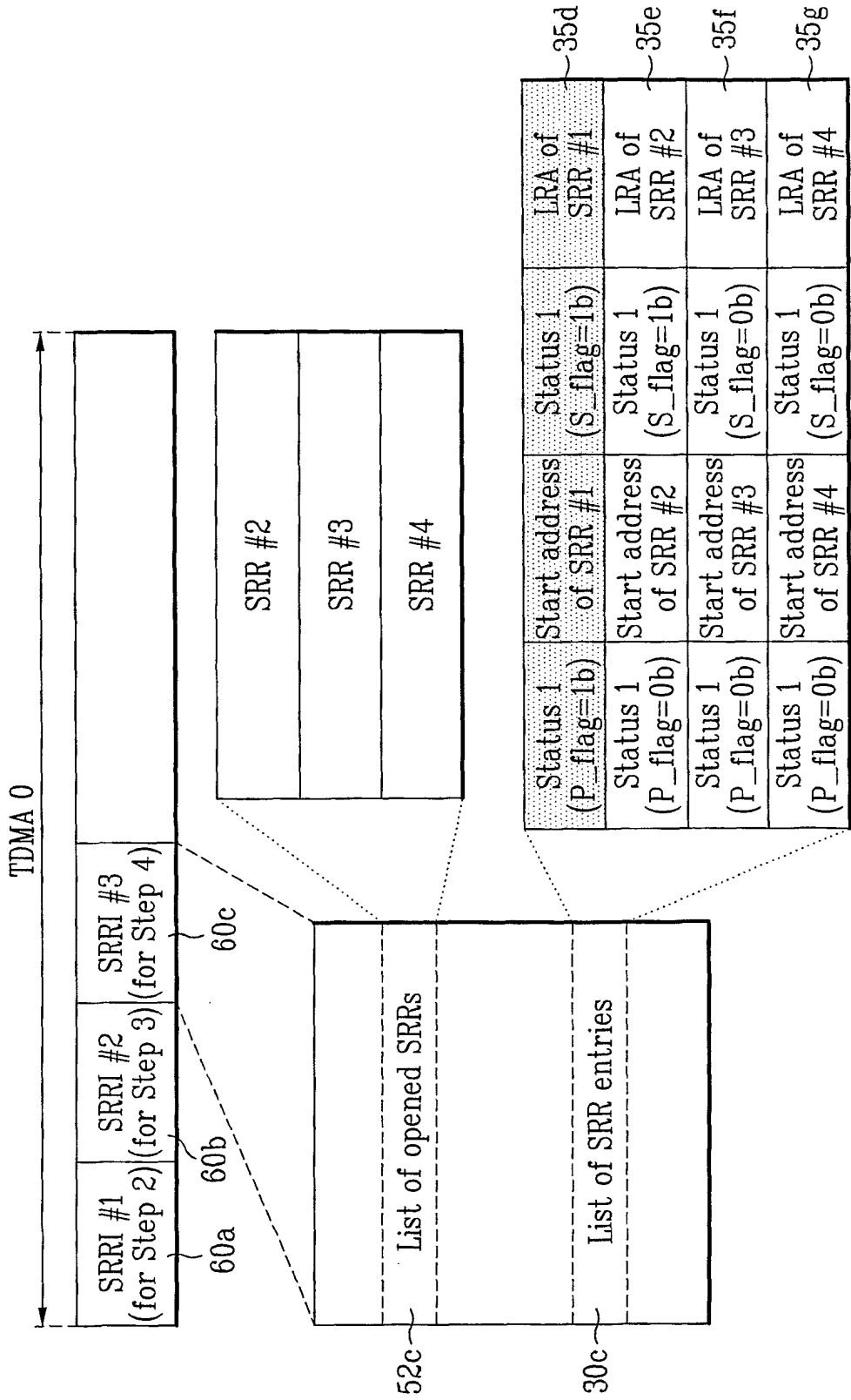

FIG. 10A

Step 5. Write some data to Empty SRR and Invisible SRR

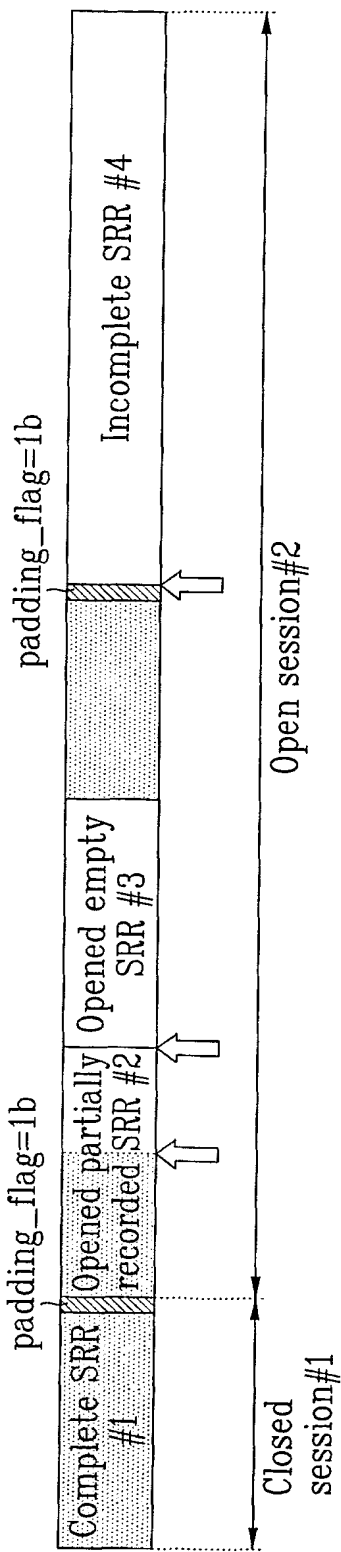

FIG. 10B

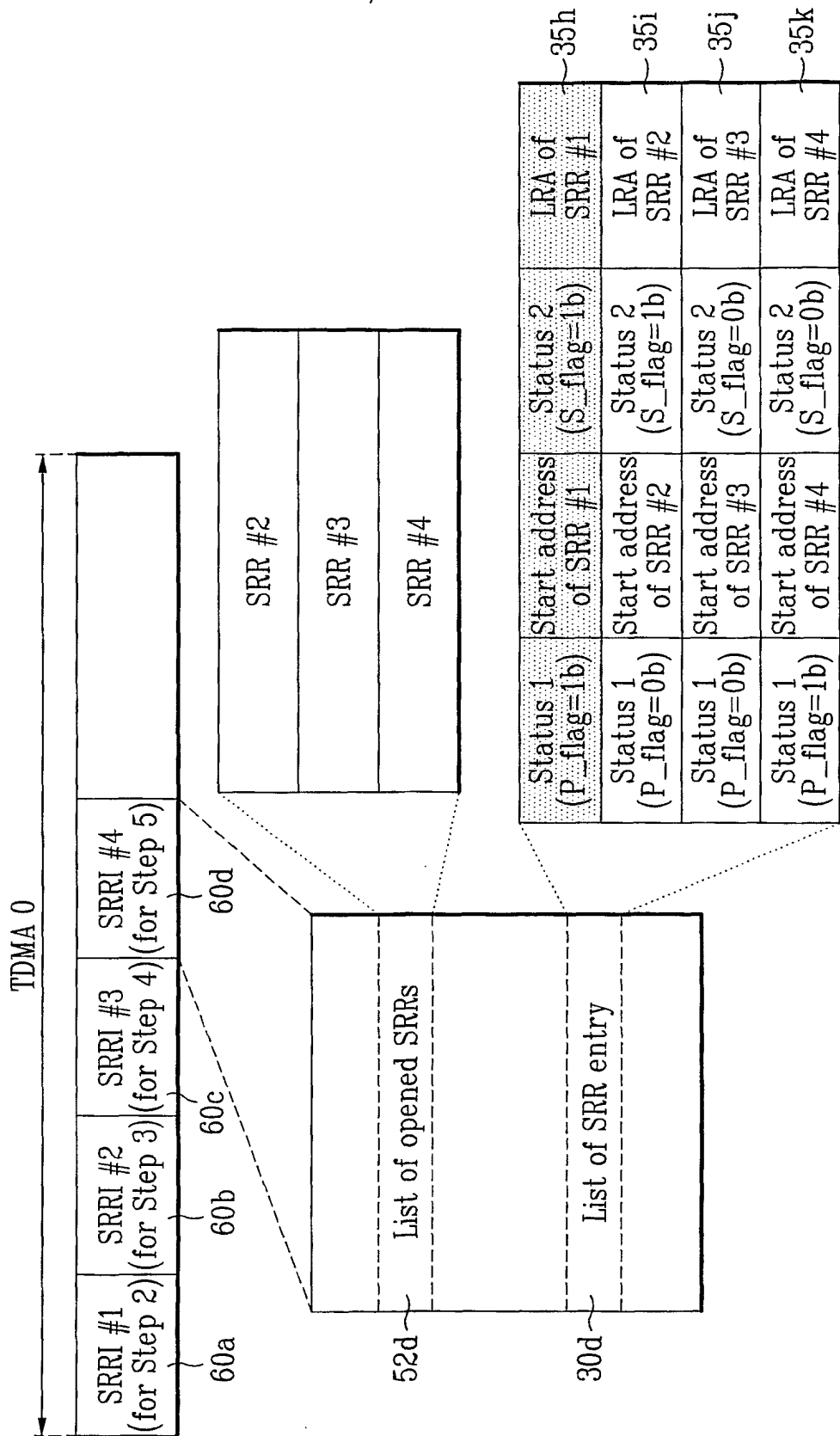

FIG. 11A

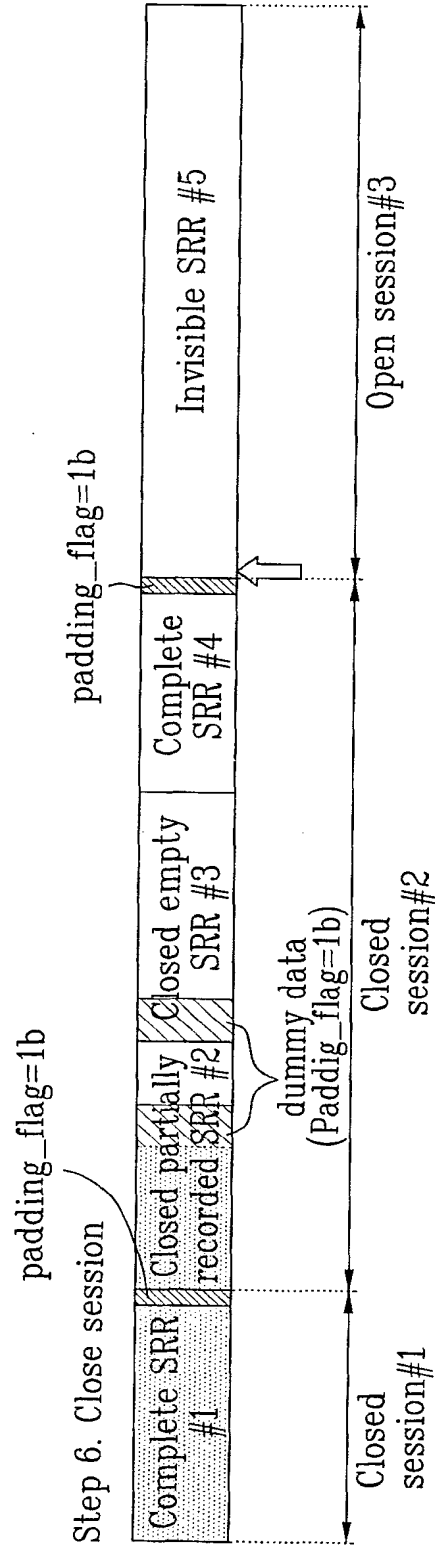

FIG. 11B

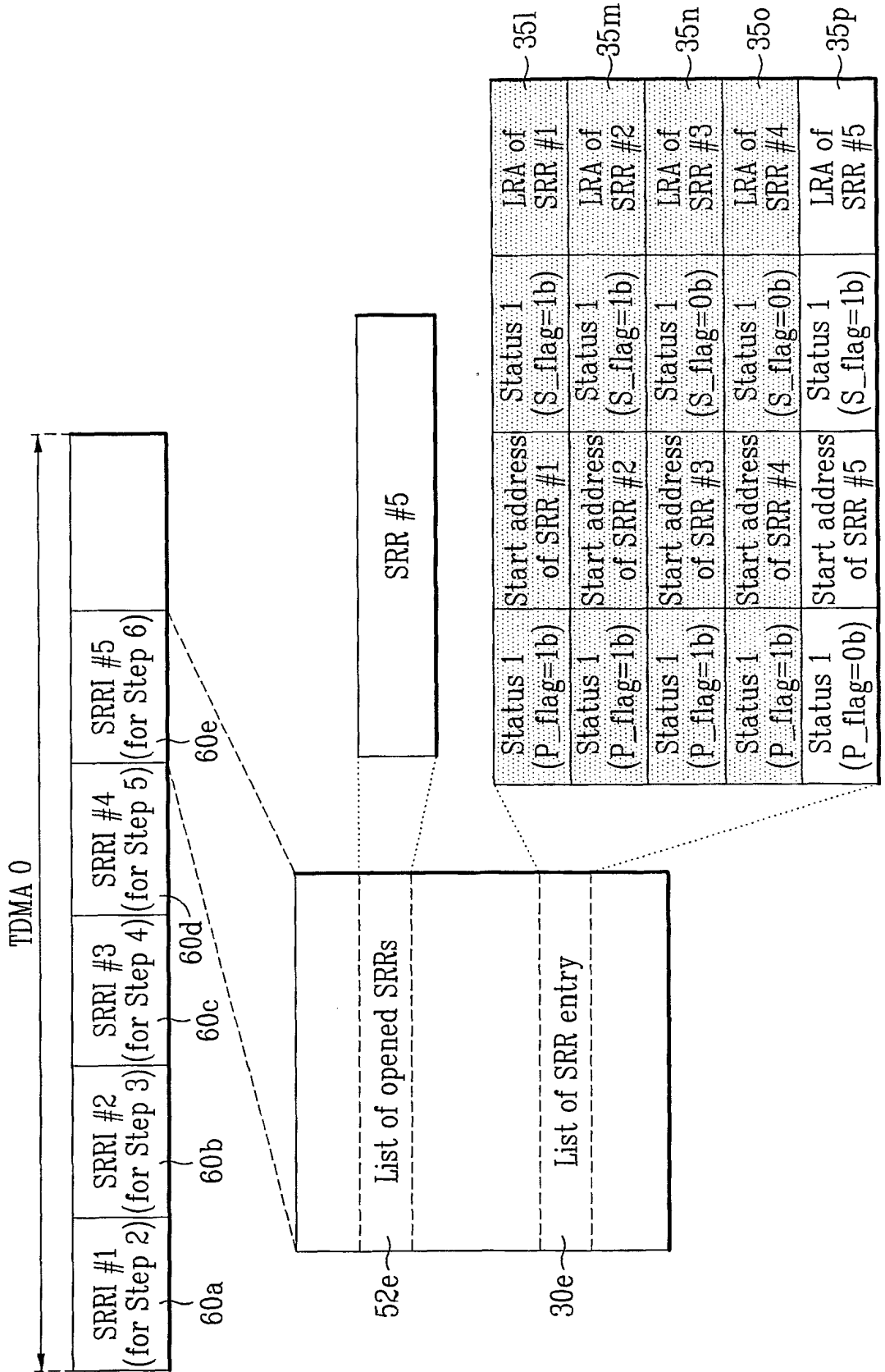

FIG. 12

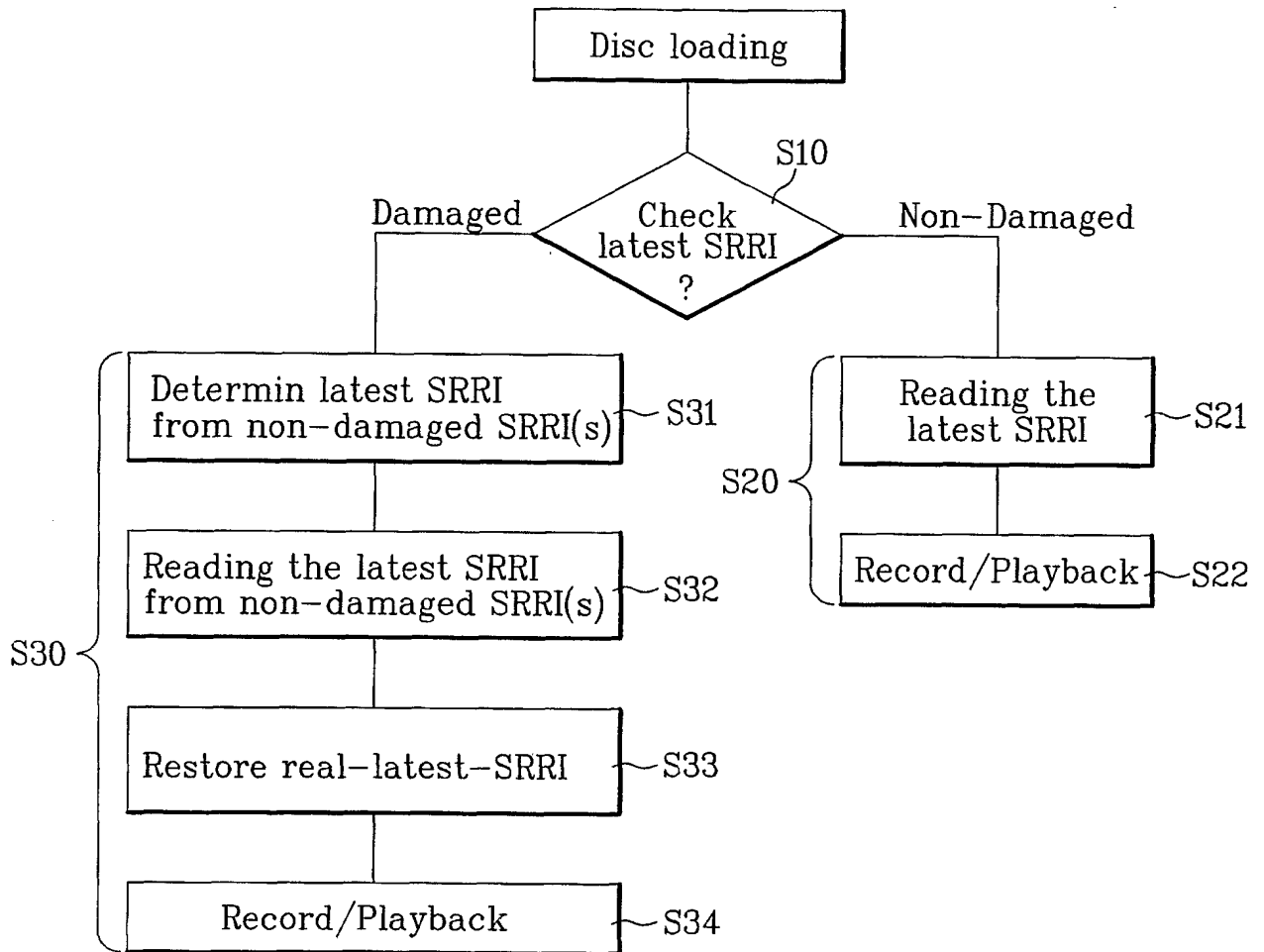

FIG. 13A

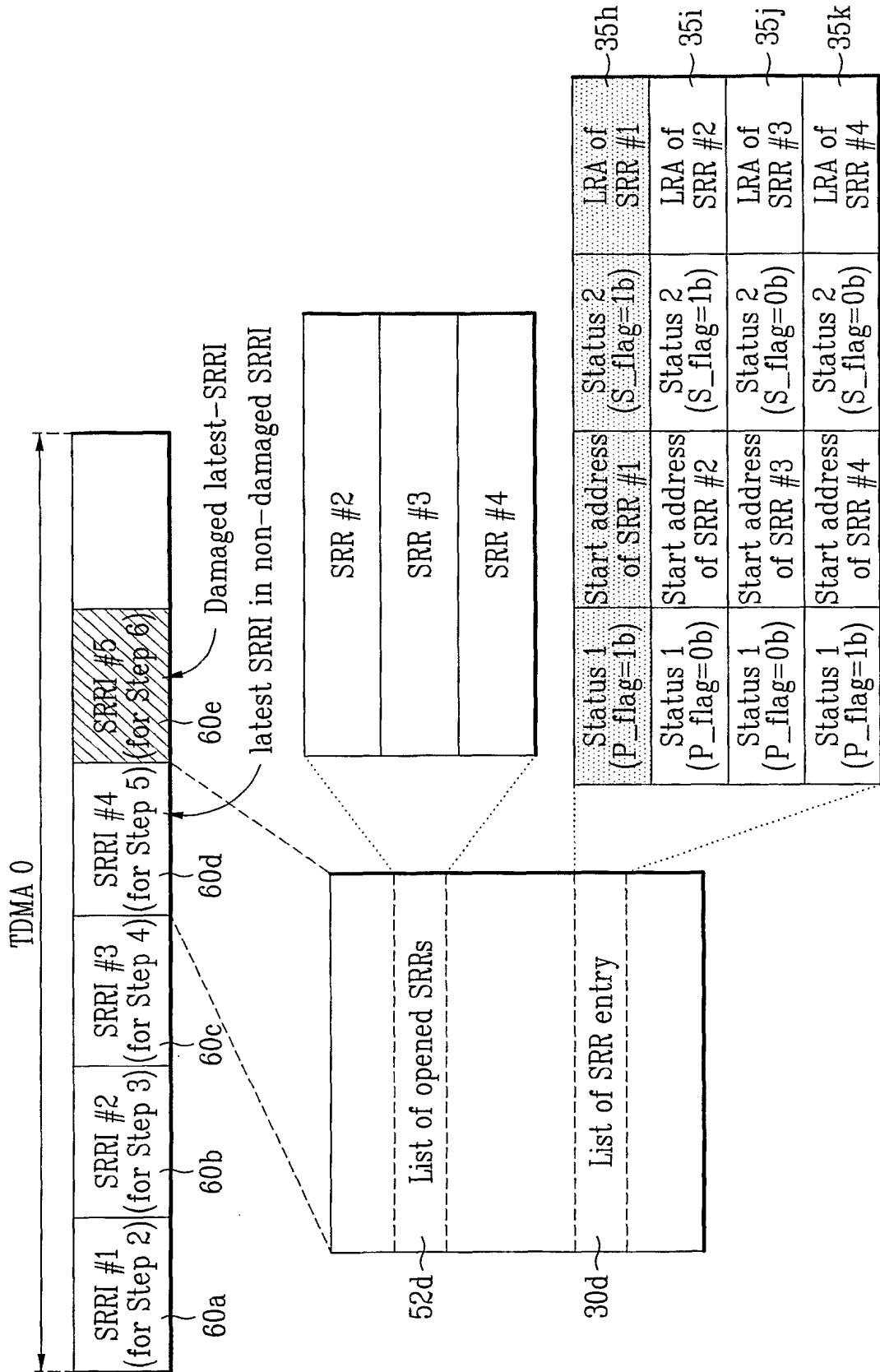

FIG. 13B

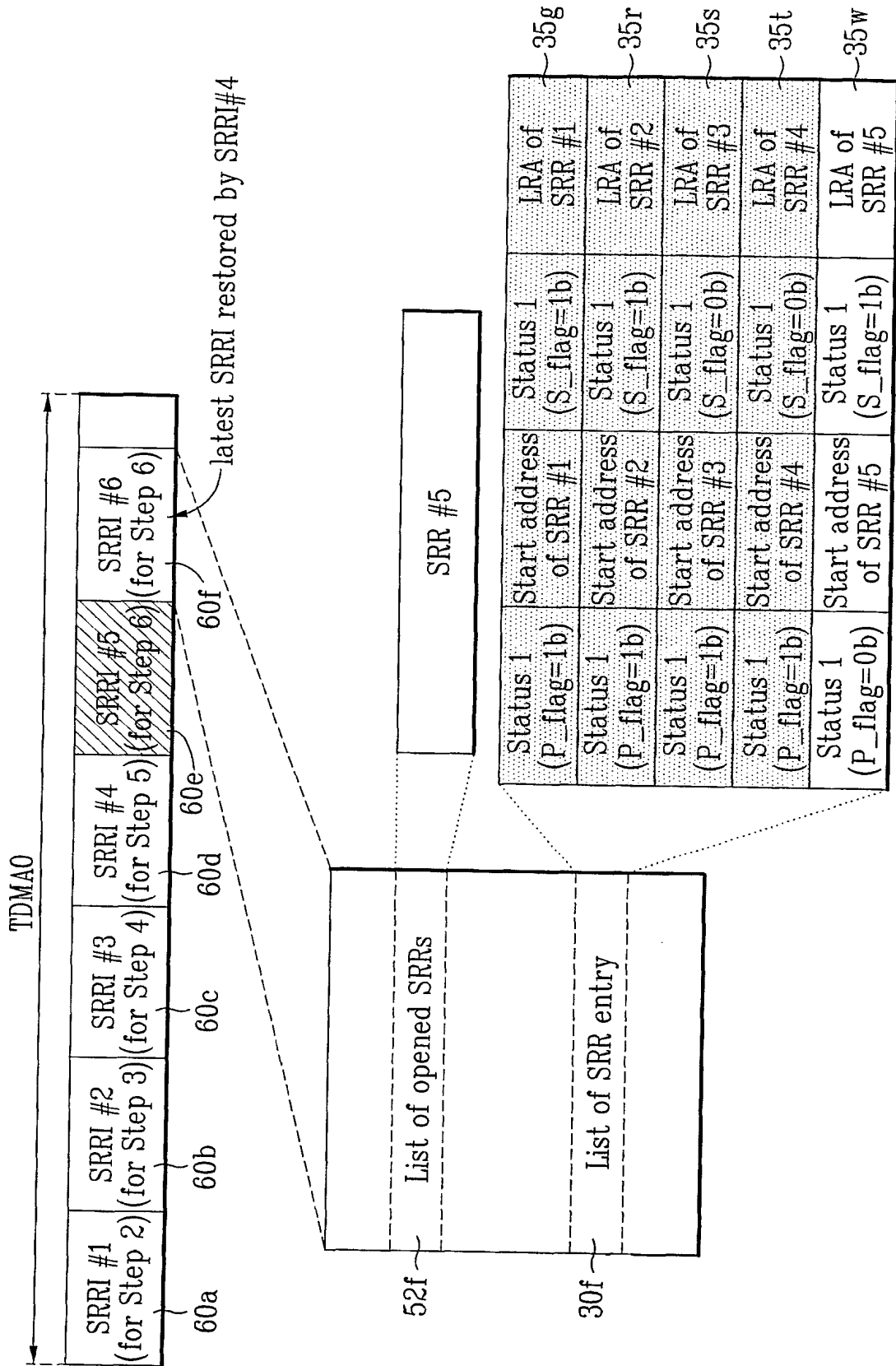
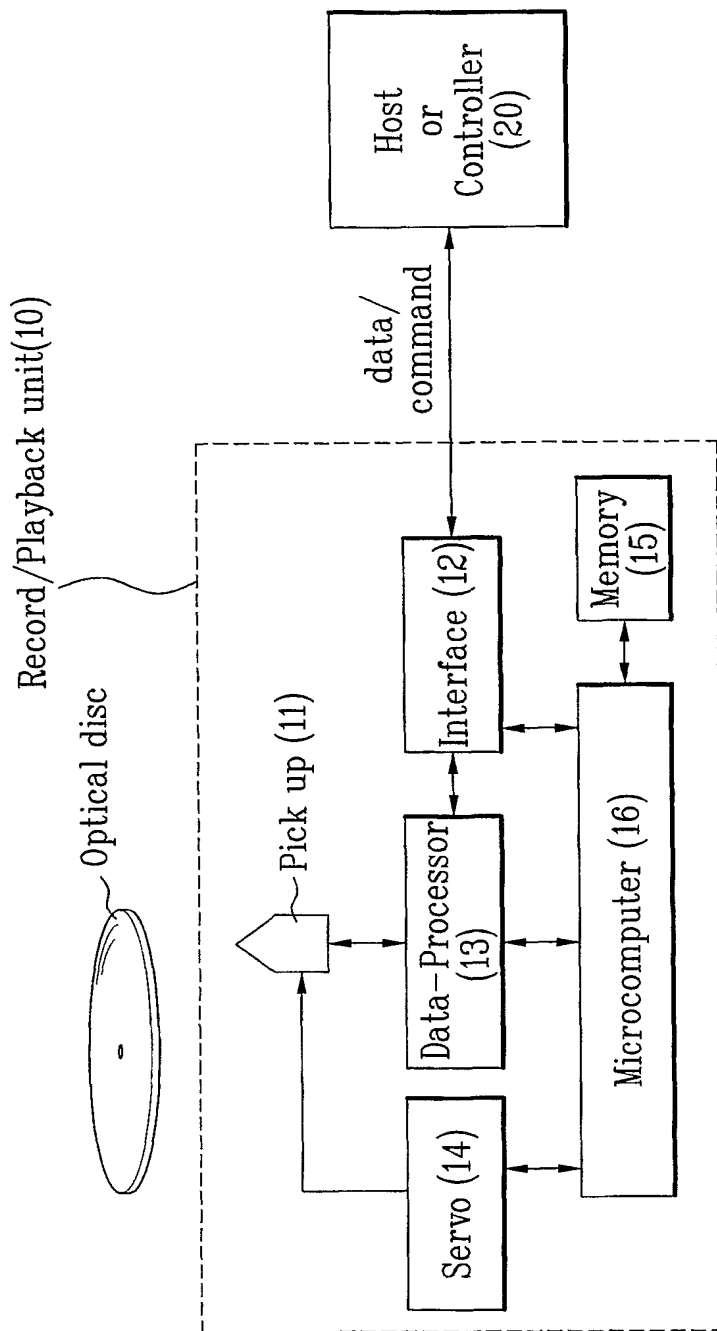

FIG. 14



(19) World Intellectual Property Organization
International Bureau



(43) International Publication Date
17 March 2005 (17.03.2005)

PCT

(10) International Publication Number
WO 2005/024792 A3

(51) International Patent Classification⁷: **G11B 20/10**

(21) International Application Number:
PCT/KR2004/002209

(22) International Filing Date:
2 September 2004 (02.09.2004)

(25) Filing Language: English

(26) Publication Language: English

(30) Priority Data:
10-2003-0062674 8 September 2003 (08.09.2003) KR
10-2003-0071127 13 October 2003 (13.10.2003) KR
10-2004-0036073 20 May 2004 (20.05.2004) KR

(71) Applicant (for all designated States except US): **LG ELECTRONICS INC.** [KR/KR]; 20, Yoido-dong, Youngdungpo-gu, Seoul 150-721 (KR).

(72) Inventor; and

(75) Inventor/Applicant (for US only): **PARK, Yong Cheol** [KR/KR]; 215-204, Jugong APT., Wonmun-dong, Gwachon-si, Gyeonggi-do 427-740 (KR).

(74) Agents: **BAHNG, Hae Cheol** et al.; KBK & Associates, 15th Floor Yo Sam Building, 648-23, Yeoksam-dong, Kangnam-gu, Seoul 135-080 (KR).

(81) Designated States (unless otherwise indicated, for every kind of national protection available): AE, AG, AL, AM, AT, AU, AZ, BA, BB, BG, BR, BW, BY, BZ, CA, CH, CN, CO, CR, CU, CZ, DE, DK, DM, DZ, EC, EE, EG, ES, FI, GB, GD, GE, GH, GM, HR, HU, ID, IL, IN, IS, JP, KE, KG, KP, KR, KZ, LC, LK, LR, LS, LT, LU, LV, MA, MD, MG, MK, MN, MW, MX, MZ, NA, NI, NO, NZ, OM, PG, PH, PL, PT, RO, RU, SC, SD, SE, SG, SK, SL, SY, TJ, TM, TN, TR, TT, TZ, UA, UG, US, UZ, VC, VN, YU, ZA, ZM, ZW.

(84) Designated States (unless otherwise indicated, for every kind of regional protection available): ARIPO (BW, GH, GM, KE, LS, MW, MZ, NA, SD, SI, SZ, TZ, UG, ZM, ZW), Eurasian (AM, AZ, BY, KG, KZ, MD, RU, TJ, TM), European (AT, BE, BG, CH, CY, CZ, DE, DK, EE, ES, FI, FR, GB, GR, HU, IE, IT, LU, MC, NL, PL, PT, RO, SE, SI, SK, TR), OAPI (BF, BJ, CF, CG, CI, CM, GA, GN, GQ, GW, ML, MR, NE, SN, TD, TG).

Published:

- with international search report
- before the expiration of the time limit for amending the claims and to be republished in the event of receipt of amendments

(88) Date of publication of the international search report:
14 July 2005

[Continued on next page]

(54) Title: WRITE-ONCE OPTICAL DISC, AND METHOD AND APPARATUS FOR MANAGEMENT INFORMATION THEREON

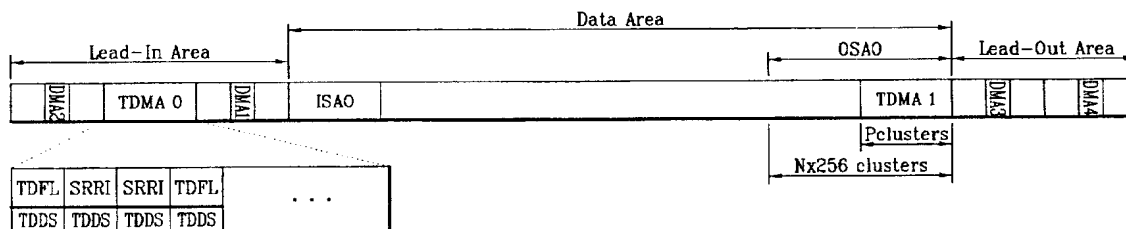

- * DMA : Disc Management Area
- * TDMA : Temporary DMA
- * ISA : Inner Spare Area
- * OSA : Outer Spare Area
- * TDFL : Temporary Defect List
- * TDSS : Temporary Disc Definition Structure
- * SRR : Sequential Recording Range
- * SRRI : SRR Information

(57) Abstract: A write-once optical disc and a method and apparatus for recording management information of the write-once optical disc, are provided. The method includes sequentially recording data in the at least one recording-unit in the direction of increasing address; padding, with padding data, a remaining non-recorded part of a last recording-unit when terminating the sequential recording of the data; and recording padding identification information on the recording medium, the padding identification information identifying which part of the at least one recording-unit is padded.

WO 2005/024792 A3

INTERNATIONAL SEARCH REPORT

International application No.
PCT/KR 2004/002209

A. CLASSIFICATION OF SUBJECT MATTER IPC ⁷ : G11B 20/10 According to International Patent Classification (IPC) or to both national classification and IPC				
B. FIELDS SEARCHED Minimum documentation searched (classification system followed by classification symbols) IPC ⁷ : G11B 20/10 Documentation searched other than minimum documentation to the extent that such documents are included in the fields searched G11B Electronic data base consulted during the international search (name of data base and, where practicable, search terms used) WPI				
C. DOCUMENTS CONSIDERED TO BE RELEVANT				
Category*	Citation of document, with indication, where appropriate, of the relevant passages	Relevant to claim No.		
A	JP 2001069440 A (SANYO) 10 March 2001 (10.03.2001) --	1, 5, 12, 15, 18, 25, 28, 30, 31		
A	JP 11203792 B2 (NEC) 4 September 2001 (04.09.2001) --	1, 5, 12, 15, 18, 25, 28, 30, 31		
A	JP 10187356 A (TOSHIBA) 14 July 1998 (14.07.1998) ----	1, 5, 12, 15, 18, 25, 28, 30, 31		
<input type="checkbox"/> Further documents are listed in the continuation of Box C. <input checked="" type="checkbox"/> See patent family annex.				
<table style="width: 100%; border: none;"> <tr> <td style="width: 50%; border: none; vertical-align: top;"> * Special categories of cited documents: "A" document defining the general state of the art which is not considered to be of particular relevance "E" earlier application or patent but published on or after the international filing date "L" document which may throw doubts on priority claim(s) or which is cited to establish the publication date of another citation or other special reason (as specified) "O" document referring to an oral disclosure, use, exhibition or other means "P" document published prior to the international filing date but later than the priority date claimed </td> <td style="width: 50%; border: none; vertical-align: top;"> "T" later document published after the international filing date or priority date and not in conflict with the application but cited to understand the principle or theory underlying the invention "X" document of particular relevance; the claimed invention cannot be considered novel or cannot be considered to involve an inventive step when the document is taken alone "Y" document of particular relevance; the claimed invention cannot be considered to involve an inventive step when the document is combined with one or more other such documents, such combination being obvious to a person skilled in the art "&" document member of the same patent family </td> </tr> </table>			* Special categories of cited documents: "A" document defining the general state of the art which is not considered to be of particular relevance "E" earlier application or patent but published on or after the international filing date "L" document which may throw doubts on priority claim(s) or which is cited to establish the publication date of another citation or other special reason (as specified) "O" document referring to an oral disclosure, use, exhibition or other means "P" document published prior to the international filing date but later than the priority date claimed	"T" later document published after the international filing date or priority date and not in conflict with the application but cited to understand the principle or theory underlying the invention "X" document of particular relevance; the claimed invention cannot be considered novel or cannot be considered to involve an inventive step when the document is taken alone "Y" document of particular relevance; the claimed invention cannot be considered to involve an inventive step when the document is combined with one or more other such documents, such combination being obvious to a person skilled in the art "&" document member of the same patent family
* Special categories of cited documents: "A" document defining the general state of the art which is not considered to be of particular relevance "E" earlier application or patent but published on or after the international filing date "L" document which may throw doubts on priority claim(s) or which is cited to establish the publication date of another citation or other special reason (as specified) "O" document referring to an oral disclosure, use, exhibition or other means "P" document published prior to the international filing date but later than the priority date claimed	"T" later document published after the international filing date or priority date and not in conflict with the application but cited to understand the principle or theory underlying the invention "X" document of particular relevance; the claimed invention cannot be considered novel or cannot be considered to involve an inventive step when the document is taken alone "Y" document of particular relevance; the claimed invention cannot be considered to involve an inventive step when the document is combined with one or more other such documents, such combination being obvious to a person skilled in the art "&" document member of the same patent family			
Date of the actual completion of the international search 19 April 2005 (19.04.2005)		Date of mailing of the international search report 4 May 2005 (04.05.2005)		
Name and mailing address of the ISA/ AT Austrian Patent Office Dresdner Straße 87, A-1200 Vienna Facsimile No. +43 / 1 / 534 24 / 535		Authorized officer GRÖSSING G. Telephone No. +43 / 1 / 534 24 / 386		

INTERNATIONAL SEARCH REPORT
Information on patent family members

International application No.
PCT/KR 2004/002209

Patent document cited in search report	Publication date	Patent family member(s)	Publication date
JP A 10187356 A2		none	
JP A 11203792 B4		none	
JP A 20010694 40A2		none	

**WRITE-ONCE OPTICAL DISC, AND METHOD AND
APPARATUS FOR RECORDING MANAGEMENT INFORMATION ON
WRITE-ONCE OPTICAL DISC**

5 **Technical Field**

The present invention relates to a writable-once optical disc and a management information recording method and apparatus, and more particularly, to a method and apparatus for efficiently recording management information on a
10 writable-once optical disc.

Background Art

Optical disc, which is a kind of optical recording media and can record a large
15 amount of data, is widely being used. Today, a kind of innovative high-density digital versatile disc (HD-DVD) such as a blue ray disc (Blu-ray Disc), which can record and store video data of high quality and audio data of high fidelity for a long time, is under development.

The Blu-ray disc is a next generation optical recording solution that can store
20 a larger amount of data than a conventional DVD. The Blu-ray disc employs a blue-violet laser with the wavelength of 405 nm which is shorter than the wavelength of 650 nm of a red laser used to access a conventional DVD. The Blu-ray disc has generally a thickness of 1.2 mm and a diameter of 12 cm. It includes a light transmission layer whose thickness is 0.1 mm so that the Blu-ray disc can store a
25 larger amount of data than the current DVDs.

Various standards related to the Blu-ray discs are in development. Among the different types of Blu-ray discs, a Blu-ray Disc Rewritable (BD-RE) and a Blu-ray Disc Write-Once (BD-WO) are being developed.

FIG. 1 schematically illustrates a structure of a recording area of a general

BD-RE. Referring to FIG. 1, the BD-RE includes a recording layer divided into a lead-in area, a data area and a lead-out area. The data area includes a user data area for recording user data thereon, and an inner spare area ISA0 and an outer spare area OSA0 each allocated in the inner tracks and the outer tracks of the disc. These spare areas are used as replacement areas for replacing data in a defective area of the user data area according to linear replacement.

In the BD-RE, if a defective area is found in the user data area during recording, data in the defective area is transferred to and recorded on a spare area. Further, as defect management information for managing the defective area, position information and the like relating to the defective area and the corresponding spare area are recorded on defect management areas (DMA 1 ~ DMA 4) in the lead-in area and the lead-out area. Also, since data can be recorded on and erased from any area of the BD-RE repeatedly (since the BD-RE is rewritable), the entire BD-RE can be randomly used irrespective of a specific recording mode.

In contrast, in a writable-once Blu-ray disc (BD-WO), data can be recorded only one time on a specific area of the disc. As a result, the BD-WO has certain limitations pertaining to recording modes and in randomly using the entire area of the disc due to the defect management difficulty.

Further, in a BD-WO, management of the defective areas is one of the important matters that needs to be addressed, especially for data recording operations. But since the BD-WO is still in the early development stage, there are no schemes, no disc structures, no apparatuses, and no methods on how to manage the defective areas of the BD-WO and record management information on the BD-WO, which will be needed for the BD-WO to be commercially viable and operationally feasible. Accordingly, for the BD-WO, a unified specification is required that would satisfy the aforementioned advanced requirements. But any proposed specification relating to the current BD-RE cannot be used because it does not address the needs of the BD-WO.

Disclosure of Invention

Accordingly, the present invention is directed to a writable-once optical disc and a management information recording method and apparatus that substantially
5 obviate one or more problems due to limitations and disadvantages of the background art.

An object of the present invention is to provide a method of recording disc management information such as timing, contents and location information in a plurality of management areas of a write-once optical disc.

10 Additional advantages, objects, and features of the invention will be set forth in part in the description which follows and in part will become apparent to those having ordinary skill in the art upon examination of the following or may be learned from practice of the invention. The objectives and other advantages of the invention may be realized and attained by the structure particularly pointed out in the written
15 description and claims hereof as well as the appended drawings.

To achieve these objects and other advantages and in accordance with the purpose of the invention, as embodied and broadly described herein, a method of recording management information on a write-once optical recording medium, the recording medium including a temporary defect management area (TDMA) and a
20 final defect management area (DMA), includes: recording, in the TDMA, management information produced while the recording medium is in use; and transferring and recording the latest management information of the TDMA in the DMA at a DMA fill-in stage of the recording medium.

In accordance with an aspect of the invention, a method of recording
25 management information on a write-once optical recording medium, the recording medium including a temporary defect management area (TDMA) and a final defect management area (DMA), the DMA including a defect list area for storing therein defect list information, includes: if no defect management is to be performed on the recording medium, setting a predetermined value in the defect list area of the DMA;

recording, in the TDMA, management information produced while the recording medium is in use; and transferring and recording the latest management information of the TDMA in the DMA when the recording medium is to be finalized.

In accordance with another aspect of the invention, an apparatus for recording management information on a write-once optical recording medium, the recording medium including a temporary defect management area (TDMA) and a final defect management area (DMA), includes a combination of elements configured for: recording, in the TDMA, management information produced while the recording medium is in use; and transferring and recording the latest management information of the TDMA in the DMA at a DMA fill-in stage of the recording medium.

In accordance with another aspect of the invention, an apparatus for recording management information on a write-once optical recording medium, the recording medium including a temporary defect management area (TDMA) and a final defect management area (DMA), the DMA including a defect list area for storing therein defect list information, includes a combination of elements configured for: setting a predetermined value in the defect list area of the DMA if no defect management is to be performed on the recording medium; recording, in the TDMA, management information produced while the recording medium is in use; and transferring and recording the latest management information of the TDMA in the DMA when the recording medium is to be finalized.

In accordance with another aspect of the invention, a write-once optical recording medium for recording management information thereon, includes: at least one recording layer including a temporary defect management area (TDMA) and a final defect management area (DMA), wherein management information produced while the recording medium is in use is recorded in the TDMA, and the latest management information of the TDMA is transferred and recorded in the DMA at a DMA fill-in stage of the recording medium.

In accordance with another aspect of the invention, a write-once optical recording medium for recording management information thereon, includes: at least

one recording layer including a temporary defect management area (TDMA) and a final defect management area (DMA), the DMA including a defect list area for storing therein defect list information, wherein if no defect management is to be performed on the recoding medium, a predetermined value is set in the defect list area of the DMA; management information produced while the recording medium is in use is recorded in the TDMA; and the latest management information of the TDMA is transferred and recorded in the DMA when the recording medium is to be finalized.

It is to be understood that both the foregoing general description and the following detailed description of the present invention are exemplary and explanatory and are intended to provide further explanation of the invention as claimed.

Brief Description of the Drawings

15

Further objects and advantages of the invention can be more fully understood from the following detailed description taken in conjunction with the accompanying drawings, in which:

FIG. 1 schematically illustrates a structure of a general single-layer BD-RE:

FIG. 2 is a block diagram of an optical recording/reproducing device according to the present invention;

FIG. 3 illustrates a structure of a writable-once optical disc such as a single layer BD-WO according to an embodiment of the present invention;

FIG. 4 illustrates an example of a DDS structure on a rewritable disc, a TDDS structure on a BD-WO and a disc management information recording method for the BD-WO according to an embodiment of the present invention;

FIG. 5 illustrates a structure of a writable-once optical disc such as a single layer BD-WO according to another embodiment of the present invention;

FIG. 6A shows an exemplary structure of a DMA of a single-layer BD-WO

according to an embodiment of the present invention;

FIG. 6B illustrates the structure of the DMA of FIG. 6A, a TDMA structure and a method of transferring data from the TDMA to the DMA according to an embodiment of the present invention;

5 FIG. 6C shows an exemplary structure of a DMA of a dual-layer BD-WO according to an embodiment of the present invention;

FIG. 7 shows a chart for explaining the timing, contents and location information associated with the DMA fill-in process of a BD-WO according to a first embodiment of the present invention;

10 FIG. 8 shows a chart for explaining the timing, contents and location information associated with the DMA fill-in process of a BD-WO according to a second embodiment of the present invention;

FIG. 9A shows a chart for explaining the timing, contents and location information associated with the DMA fill-in process of a BD-WO according to a
15 third embodiment of the present invention;

FIG. 9B shows an example of the DMA to which the DMA fill-in process of FIG. 9A is applied; and

FIG. 10 shows examples of values of a TDDS/DDS status flag recorded as part of the DDS information in the DDS section of the DMA according to the present
20 invention.

Best mode for Carrying Out the Invention

Reference will now be made in detail to the preferred embodiments of the
25 present invention, examples of which are illustrated in the accompanying drawings. Wherever possible, the same reference numerals will be used throughout the drawings to refer to the same or like parts.

FIG. 2 is an example of a block diagram of an optical disc recording/reproducing device 20 according to an embodiment of the present

invention. The optical disc recording/reproducing device 20 includes an optical pickup 22 for writing/reading data to/from an optical recording medium 21, a servo unit 23 for controlling the pickup 22 to maintain a distance between an objective lens of the pickup 22 and the recording medium 21 and for tracking relevant tracks on the recording medium 21, a data processor 24 for processing and supplying input data to the pickup 22 for writing, and for processing data read from the recording medium 21, an interface 25 for exchanging data and/or commands with any external host 30, a memory or storage 27 for storing information and data therein including defect management data as needed (e.g., temporary defect management information, etc.) associated with the recording medium 21, and a microprocessor or controller 26 for controlling the operations and elements of the recording/reproducing device 20. Data to be written/read to/from the recording medium 21 may also be stored in the memory 27 if needed. All the components of the recording/reproducing device 20 are operatively coupled. The recording medium 21 is a recording medium of write-once type such as a BD-WO.

All the methods and disc structures discussed herein according to the present invention can be implemented using the recording/reproducing device 20 of FIG. 2 or any other suitable device/system. For example, the microcomputer 26 of the device 20 may be used to control allocation of the disc structure and to control the recording of management information on the recording medium and the transferring of the management information from a temporary area (e.g., TDMA) to a permanent or final area (e.g., DMA) on the recording medium 21. The TDMA and DMA will be discussed later in more detail.

A management information recording method for a writable-once optical disc such as a BD-WO according to the preferred embodiments of the present invention will be now described in detail with reference to the accompanying drawings. For a discussion convenience, a writable-once Blu-ray disc (BD-WO) will be exemplified. Herein, two types of a BD-WO - a single layer BD-WO and a dual layer BD-WO - are discussed. The single layer BD-WO has a single recording layer, whereas the

dual layer BD-WO has two recording layers.

FIG. 3 illustrates a structure of a writable-once optical recording medium such as a single-layer BD-WO according to an embodiment of the present invention. Referring to FIG. 3, the BD-WO includes a lead-in area, a data area, and a lead-out area allocated on the single recording layer. Each of the lead-in area and the lead-out area includes a plurality of defect management areas (DMA 1 and DMA 2; DMA 3 and DMA 4) for storing therein DMA information for defect management. Each of the DMAs 1-4 has a fixed size, e.g., 32 clusters. Generally, in view of the importance of defect management, the same information is written in each of the DMAs 1-4 so that if one of the DMAs is defective, then a different DMA can be accessed to obtain the defect management information.

It should be noted that in a general BD-RE, since data can be repeatedly recorded on and erased from a DMA (although the size of the DMA is limited), a DMA of large size is not required. However, in a BD-WO according to the present invention, since data cannot be repeatedly recorded on and erased from the DMA, a DMA of large size is required for defect management.

Still referring to FIG. 3, the lead-in area further includes a temporary defect management area (TDMA 1) for temporarily storing defect management information therein. The data area includes an inner spare area ISA0, a user data area, and an outer spare area OSA0. Parts of or the entire ISA0 and OSA0 are used as replacement areas for defective areas in the user data area according to linear replacement. For instance, during a recording of data into the user data area, if a defective area in the user data area is detected, then the data written or to be written to this defective area is transferred to a spare area (e.g., ISA0 or OSA0) according to a linear replacement scheme. The outer spare area OSA0 includes a temporary defect management area (TDMA 2). The defect management information temporarily stored in the TDMA 1 and/or TDMA 2 is also referred to herein as TDMA information.

In one embodiment, the TDMA 1 allocated to the lead-in area has a fixed size,

whereas the TDMA 2 allocated to the outer spare area OSA0 has a variable size depending upon the size of the spare area(s). For example, if the OSA0 has a size of $N \times 256$ clusters where $N > 0$ ($N = \text{integer}$), then the TDMA 2 has a size of P clusters where $P = (N \times 256)/4$.

5 In one example, the same information may be written in each of the TDMAs 1 and 2. In another example, the TDMAs 1 and 2 may be sequentially used to sequentially record the TDMA information. Regardless, during replacement writing operations for writing data of a defective area onto a spare area, TDMA information is generated (e.g., under control of the microcomputer 26) and written onto the
10 TDMAs 1 and/or 2. The TDMAs are also updated periodically or as needed. When the BD-WO is ready to be finalized or the DMA is to be filled in for other reasons, then the TDMA information (latest version) temporarily written in the TDMA(s) is transferred and written onto one or each of the DMAs 1-4. This transfer process will be discussed later in more detail.

15 The TDMA information written in each of the TDMAs 1 and 2 includes temporary defect list (TDFL) information and temporary disc definition structure (TDDS) information. In one embodiment, the TDFL information includes one or a plurality of TDFLs (TDFL #1 ~ TDFL #n). Each TDFL includes one or a plurality of defect entries identifying defects and corresponding replacement areas on the disc.
20 Each defect entry includes location information pertaining to a defective area of the user data area and the corresponding replacement area. For example, during a data recording operation on the BD-WO, if a defective area is found in the user data area, then data written or to be written in that defective area is written in a part (replacement area) of a spare area (e.g., ISA0 or OSA0) according to a linear
25 replacement scheme. Then the information pertaining to the defective area and the replacement area and their relationship is entered as a defect entry in the TDFL. For instance, this information may include a first physical sector number of the defective area on the disc, a first physical sector number of the replacement area (spare area) corresponding to that defective area, and any other data pertaining to the defect for

defect management.

In one embodiment, the TDDS information written in each of the TDMA 1 and 2 includes one or a plurality of TDDSs (TDDS #1 ~ TDDS #n). Each TDDS has a fixed size (e.g., one cluster) and includes location information pertaining to the TDFL(s) so that the location of any TDFL can be quickly identified by accessing the TDDS(s). This location information is also referred to herein as the TDDS part and can be written in a portion of Sector 0 of the one cluster. Here, a cluster has 32 sectors each sector having 2048 bytes. As an example only, the TDDS part may include one or more physical sector numbers each indicating a location of a TDFL written on the BD-WO, and any other information pertaining to the TDFL information.

Furthermore, each TDDS includes recording mode information (RM) and disc usage management information. The recording mode information identifies a recording mode of the BD-WO and can be written in a portion of Sector 0 of the one cluster. The disc usage management information identifies the status of a recording area of the BD-WO, and can be represented in one of the two forms: track information (Track-Info) and space bitmap information (SBM). This structure of the TDDS will be discussed in more detail later by referring to FIG. 4.

As the data recording operation for writing data into the data area progresses, the TDMA 20 may be updated periodically to reflect any recently discovered defective areas and corresponding replacement areas. After each updating of the TDMA, a TDFL and a corresponding TDDS, which may include all previous TDMA information and the recently generated TDMA information, may be written in the TDMA. In this aspect, the latest TDDS and TDFL written in the TDMA of the BD-WO 25 would include the latest TDMA information. Then when the BD-WO is to be finalized or the DMA(s) is ready to be filled in, the latest TDDS and TDFL written on the BD-WO are transferred and written in one or each of the DMAs 1-4 as the final and most-updated defect management information.

FIG. 4 illustrates a DDS structure of a rewritable disc, an example of a TDDS

structure on a BD-WO and a disc management information recording method for the BD-WO according to an embodiment of the present invention. As shown in FIG. 4, in the DDS of a general rewritable optical disc, only 60 byte information corresponding to an extremely small portion of 1 cluster is used to store therein the DDS information. The entire remaining part of the DDS is all set to 'zero padding'.
5

In contrast, in the BD-WO, the entire TDDS area is used to store therein the TDDS information. As shown in FIGS. 3 and 4, the TDDS part and the recording mode information are written in Sector 0 of the cluster assigned as the TDDS, whereas Sectors 1-31 store therein the disc usage management information (Track-Info or SBM). In another example, the disc usage management information can be recorded on the first 31 sectors (Sectors 0 ~ 30) in the TDDS, and any remaining disc usage management information can be recorded on the last 32nd sector (Sector 31) in the TDDS along with the TDDS part and recording mode information.
10

The recording mode information identifies one of a plurality of recording modes employed in the BD-WO according to the present invention. In this example, a value of "0000 0000" may be used to indicate a sequential recoding mode, and a value of "0000 0001" may be used to indicate a random recording mode. Obviously, other examples are possible. Information about the BD-WO according to the present invention can be variously determined depending upon the needs through a process of specification regulation.
15
20

The disc usage management information is varied in dependence upon the disc usage. In the BD-WO, the disc usage management information is required for accurately searching and detecting the start point of an available recording area, and is used to distinguish a recording area from a non-recording area on the disc. In this aspect, the disc usage management information indicates where the available recording area and the recorded area are located within the data area (e.g., user data area).
25

As mentioned above, the disc usage management information can be represented as either the track information (Track-Info) or the space bitmap

information (SBM). The Track-Info is generally used when the BD-WO is recorded in a sequential recording mode. The SBM is generally used when the BD-WO is recorded in a random recording mode. These recording modes can be determined depending on the recording mode identified in the recording mode information stored in the TDDS.

In conventional writable-once optical discs, the recording status/mode information is expressed as 'track information' in case of compact disc series, and as 'Rzone', 'Fragment' or 'recording range' in case of DVD series. But in the present invention, the aforementioned various expressions relating to the recording status/mode information are commonly designated as 'Track-Info', and accordingly the Track-Info will be appreciated as having such meaning irrespective of expressions.

In one example, since the tracks on the BD-WO are sequentially used to record during the sequential recording mode, the Track-Info identifies the start point (location) of the recording area (e.g., user data area) of the BD-WO, and the end point (location) of the last recorded portion of the recording area. This information then indicates the start of the next available portion of the recording area on the BD-WO.

The bitmap information identifies a start point of an available recordable portion of the recording area on the BD-WO using bit values such as '0' and '1'. For instance, if a particular cluster area of the recording area on the BD-WO has been recorded, then it is indicated by allocating a value of '1' to every minimal recording unit (1 cluster). If a cluster area of the recording area has no recorded data thereon, then that cluster is assigned to a value of '0'. In this manner, if the SBM indicates that a particular cluster has a value of '1' assigned thereto, then it indicates that that cluster has been already used (i.e., it has recorded data thereon). If the SBM indicates that a particular cluster has a value of '0', then it indicates that that cluster has not been used yet (i.e., it has no recorded data thereon). Obviously, the reversal or some other values may be used to indicate the recording/non-recording state of

each area unit such as the clusters of the user data area. Thus, the SBM makes it possible to express a recording usage status of the disc even in the random recording mode.

FIG. 5 illustrates a structure of a writable-once optical disc such as a single layer BD-WO according to another embodiment of the present invention. The BD-WO structure of FIG. 5 is identical to the BD-WO structure of FIG. 3, except that the TDDS part and the recording mode information (RM) of TDDS information are updated and written after each update state as shown in FIG. 5. In this aspect, the disc usage management information (Track-Info or SBM) is stored in Sectors 0-30 of one cluster of the TDMA, and the TDDS part and RM are stored in Sector 31 of the one cluster. In another example, the TDDS part and RM may be stored in Sector 0 of one cluster of the TDMA, and the Track-Info or SBM may be stored in Sectors 1-31 of the one cluster.

Now, the method of transferring the TDMA information from the TDMA to the DMA according to the embodiments of the present invention will be explained by referring to FIGS. 6A-10. This transfer process is also called a DMA fill-in process.

FIG. 6A shows an exemplary structure of a DMA of a single-layer BD-WO, and FIG. 6B illustrates the structure of the DMA of FIG. 6A, a TDMA structure and a method of transferring data from the TDMA to the DMA according to an embodiment of the present invention. The DMA shown in FIGS. 6A and 6B equals one or each of the DMAs 1-4 shown in FIG. 3.

Referring to FIGS. 6A and 6B, the DMA is composed of 32 clusters. The Clusters 1-4 of the DMA are designated as a DDS section, whereas the Clusters 5-32 of the DMA are designated as a DFL section. All the clusters of the DMA in the BD-WO are designated for storing management data.

During the DMA fill-in process, the latest TDDS information from the TDMA is transferred to and recorded in each of Cluster 1 to Cluster 4 of the DMA as DDS information. In this example, the latest TDDS part (T0) and the latest disc

usage management information (Track-Info or SBM) (D0) of the TDDS information are transferred onto the DMA. As a result, the same DDS information is four times recorded in the DMA. The latest TDFL information from the TDMA is also transferred to and recorded in Clusters 5-32 of the DMA as DFL information. Here, the same DFL information can be recorded in the DMA up to seven times by designating four clusters of the DMA for recording the DFL information therein. In one example, the TDDS part written in the DDS section of the DMA may identify the location of the DFLs in the DMA on the BD-WO, and not necessarily the location of the TDFLs in the TDMA on the BD-WO. Storing the same information repeatedly in the DDS section or the DFL section ensures that the DMA information is not lost (e.g., due to a defect in a portion of the DMA) and is accurately and completely accessed each time it is needed.

FIG. 6C shows an exemplary structure of a DMA of a dual-layer BD-WO according to an embodiment of the present invention. Referring to FIG. 6C, one DMA of the dual-layer BD-WO is composed of a DMA part (Clusters 1-32) from a first recording layer L0 of the BD-WO, and a DMA part (Clusters 33-64) from a second recording layer (L1) of the BD-WO, which are accessed according to the tracking direction indicated with the arrow. The same DDS information (e.g., for both recording layers) is repeatedly recorded on the Clusters 1-8 of the DMA, and the same DFL information is repeatedly recorded on the Clusters 9-64 of the DMA, up to the maximum of, e.g., seven times. In addition, the BD-WO includes a lead-in area, a data area and an outer zone area on the first recording layer, and a lead-out area, a data area and an outer zone area on the second recording layer. Each of the data areas may include at least one spare area and a user data area. The lead-in area of the first recording layer may include a TDMA and first and second DMAs. The lead-out area of the second recording layer may include another TDMA and first and second DMAs. Here, as an example, one DMA shown in FIG. 6C may be composed of the first DMAs from the first and second recording layers, or of the second DMAs from the first and second recording layers. Additional DMAs may also be provided

in the outer zone areas. The spare area(s) may include additional TDMA(s).

Similar to the single layer BD-WO, the TDMA(s) in the lead-in/lead-out area of the dual layer BD-WO may have a fixed size, whereas the TDMA(s) in the spare areas may have a variable size depending upon the size of the spare area(s). The use and structure of the DMAs and TDMA(s) on the single layer BD-WO as discussed
5 herein applies equally to the DMAs and TDMA(s) on the dual layer BD-WO.

In one embodiment, the latest disc usage management information is recorded each on the front part of a first DMA in the lead-in area and/or on the front/rear part of a DMA in the lead-out area (depending on whether the disc has a single or
10 multiple recording layers). This allows the disc usage management information to be accessed quickly at the initial loading time of the disc. Further, the data reliability and data preservation can be assured by repetitive recording of same information in different parts of the disc.

FIG. 7 shows a chart for explaining the timing, contents and location
15 information associated with the DMA fill-in process of a BD-WO according to a first embodiment of the present invention. This DMA fill-in process is applicable to the BD-WO structures shown in FIGS. 3 and 5-6C, or other suitable BD-WO structures.

Referring to FIG. 7, the time for transferring the TDMA information into the DMA of the BD-WO is when the BD-WO is to be finalized. Defect management is
20 performed on the BD-WO. As a result, the TDMA information produced while the BD-WO is in use is recorded in the TDMA, and when the BD-WO is to be finalized, the latest TDMA information from the TDMA is transferred to and recorded in the DMA.

The time for finalization is generally divided into three cases. The first case
25 (50a) is when no more recording is performed on the BD-WO (e.g., data recording in the user data area is completed, or no user data area remains on the disc). The second case (50b) is when the TDMA is full of data and no further TDMA information can be recorded therein. As one example only, this case may occur if the entire TDMA(s) for recording the TDMA information have been used. The third case

(50c) is when the user requests a finalization of the BD-WO. As one example only, the user or host may request the finalization of the BD-WO even though some user data area or the TDMA is not full, or even though the user data recording in the user data area is not completed.

5 In all three cases of timing, the contents transferred from the TDMA to the DMA are the latest TDDS and TDFL information written in the TDMA of the BD-WO. The latest TDDS information and the latest TDFL information written in the TDMA are transferred to a DDS section and a DFL section of the DMA, respectively, during the DMA fill-in process.

10 FIG. 8 shows a chart for explaining the timing, contents and location information associated with the DMA fill-in process of a BD-WO according to a second embodiment of the present invention. This DMA fill-in process is applicable to the BD-WO structures shown in FIGS. 3 and 5-6C or other suitable BD-WO structures.

15 The second embodiment addresses a scenario when the defect management (DM) on the BD-WO is not to be performed. Whether or not the DM is to be performed on the BD-WO can be determined during the initialization of the BD-WO or some other time based on known factors such as a user or host command not to perform defect management, etc. Referring to FIG. 8, if it is determined that the DM
20 is not be performed (50d) on the BD-WO (e.g., when the disc is initialized), then a specified value, sign or other indication is set in a DFL section of the DMA. This indication indicates that no DM is performed on the BD-WO (e.g., no defect lists are recorded on the BD-WO or no linear replacement schemes are performed to transfer the data of a defective user area to a replacement/spare area). When no DM is to be
25 performed, A/V (audio/video) data can be recorded in real time. Here, since no DM is performed during the disc recording (e.g., into the user data area), no TDFLs are generated and the predetermined value or some other fixed indication can be set in the DFL section of the DMA. In one example, the predetermined value for indicating no DM is set in the DFL section of the DMA in advance before the

finalization of the BD-WO (e.g., at the disc initialization). At this time, the entire DFL section of the DMA may be padded with the zero value. In another variation, a predetermined value (e.g., zero) or some other indication may be set in the TDFL area of the TDMA, and then this value (TDFL information) may be transferred to the DFL section of the DMA while the TDDS information is transferred to the DDS section of the DMA during the DMA-fill in process (i.e., at the finalization of the BD-WO).

The process of transferring the TDDS information from the TDDS of the TDMA to the DDS section of the DMA in the second embodiment is identical to that of the first embodiment of FIG. 7. More specifically, after it is determined that no DM is to be performed on the BD-WO and then when the BD-WO is ready to be finalized, then the TDDS information is transferred to the DDS section of the DMA. As shown in FIG. 8, during the finalization of the BD-WO, in the first case (50a) when no more recording is performed on the BD-WO, in the second case (50b) when the TDMA is full, and in the third case when the user requests finalization of the BD-WO, the latest TDDS information from the TDMA is transferred and recorded in the DDS section of the DMA as part of DMA fill-in process.

For example, if the DMA fill-in process of FIG. 8 is applied to the DMA structure of FIG. 6A, the Clusters 1-4 of the DMA would store therein the predetermined value (e.g., zero), and the latest TDDS information from the TDMA is transferred and recorded in the DDS section of the DMA. As discussed above, the same latest TDDS information can be recorded up to seven times in the Cluster 5-32 of the DMA. That is, in the maximum 7 repetition recording, the same latest TDDS information is written in the Clusters 5-8, the Cluster 9-12, the Cluster 13-16, ... and the Clusters 29-32 of the DMA.

FIG. 9A shows a chart for explaining the timing, contents and location information associated with the DMA fill-in process of a BD-WO according to a third embodiment of the present invention. This DMA fill-in process is applicable to the BD-WO structures shown in FIGS. 3 and 5-6C or other suitable BD-WO

structures.

The third embodiment addresses a scenario when no more data can be recorded in the user data area of the BD-WO, but the spare area(s) and the TDMA(s) are not full and can still be used to perform defect management. If any recordable area remains in the spare area (e.g., ISA0 and OSA0) and the TDMA (e.g., TDMA 1 and 2) even though no more recordable area exists in the user data area of the BD-WO (e.g., because the user data area is full, etc.), then at that time, the latest TDDS and TDFL information from the TDMA is transferred and recorded into an area of the DMA. Subsequently, when the BD-WO is ready to be finalized, the latest TDDS and TDFL information at that time from the TDMA is transferred and recorded into another area of the DMA, such as the remaining area of the DMA.

Referring to FIG. 9A, in this embodiment, the DM is performed even during the reproduction of the BD-WO. Particularly, if the spare area and the TDMA are not full and are available for use in the DM even though the recordable user data area is not available (50e), the latest TDMA information of the TDMA at this time is transferred and recorded in only a partial area of the DMA before the finalization of the BD-WO. Subsequently, when the BD-WO is to be finalized (50b or 50c), the latest TDMA information of the TDMA at that time is then transferred and recorded in the remaining or another area designated of the DMA.

Here, the time for finalization is divided into two cases 50b and 50c, which are identical to the two cases 50b and 50c in FIG. 7. Briefly, the first case (50b) is when the TDMA is full of data and no further TDMA information can be recorded therein. The second case (50c) is when the user requests a finalization of the BD-WO.

FIG. 9B shows an example of the DMA to which the DMA fill-in process of FIG. 9A is applied. As shown in FIG. 9B, when the situation 50e occurs, the latest TDDS information is written as DDS information into two clusters (e.g., Clusters 1 and 2) of the DMA, and the latest TDFL information is written as DFL information into four clusters (e.g., Clusters 5-8) of the DMA. Here the latest TDFL information

is written once in Clusters 5-8 without any repetition. Then when the disc is to be finalized (50b or 50c), the latest TDDS information of that time is written as DDS information into two clusters (e.g., Clusters 3 and 4) of the DMA and the latest TDFL information of that time is written as DFL information into the remaining
5 clusters of the DMA. For instance, the same TDFL information can be written up to six times in the Clusters 9-32 of the DMA. Other variations are possible.

FIG. 10 shows examples of values of a TDDS/DDS status flag recorded as part of the DDS information in the DDS section of the DMA according to the present invention. Such status flag can be used in all the disc structures and methods
10 discussed herein according to the different embodiments of the present invention. This status flag informs the user, host or other entity under which status/case the TDDS or DDS information has been recorded on the BD-WO. The TDDS or DDS status flag may be of one-byte size or some other size.

For instance, in each of the above-discussed first to third embodiments of the
15 present invention, the DDS information written in the DDS section of the DMA may include a DDS status flag. Similarly, the TDDS information written in the TDMA may include a TDDS status flag. One status flag having different values may be used to indicate different recording statuses of the TDDS and DDS information. In the alternative, separate TDDS status flag and DDS status flag can be used.

Referring to FIG. 10, if the same status flag is used for both the TDDS and
20 DDS information, then the status flag of '0000 0000' may mean that the BD-WO is finalized in response to the user's request (50c) and that the management information (e.g., DDS information) is recorded in the DMA. The status flag of '0000 1111' may mean that the BD-WO is finalized because no more recording is
25 allowed in the user data area (50a) and that the management information (e.g., DDS information) is recorded in the DMA. The status flag of '1111 0000' may mean that the BD-WO is finalized because the TDMA is full (50b) and that the management information (e.g., DDS information) is recorded in the DMA. The status flag of '1111 1111' may mean that the management information (e.g., TDDS information)

is recorded in the TDMA while the disc is in use. Obviously other variations or status flag values are possible.

Industrial applicability

5

Using the status flag discussed above, the status of the BD-WO can be determined or confirmed. For instance, when the disc is loaded for reproduction, the TDDS/DDS status flag value can be examined to determine under what circumstances and in what manner the DMA fill-in process occurred on the disc.

10 Thus, the efficient use of the disc can be assured.

It will be apparent to those skilled in the art than various modifications and variations can be made in the present invention. Thus, it is intended that the present invention covers the modifications and variations of this invention provided they come within the scope of the appended claims and their equivalents.

What is claimed is:

1. A method of recording management information on a write-once optical recording medium, the recording medium including a temporary defect management area (TDMA) and a final defect management area (DMA), the method
5 comprising:

recording, in the TDMA, management information produced while the recording medium is in use; and

transferring and recording the latest management information of the TDMA
10 in the DMA at a DMA fill-in stage of the recording medium.

2. The method of claim 1, wherein the DMA fill-in stage of the recording medium is when the recording medium is to be finalized.

3. The method of claim 2, wherein the recording medium is to be finalized
15 when no more recording in a user data area of the recording medium is allowed.

4. The method of claim 3, wherein in the transferring step, the latest management information includes latest temporary defect list information and latest
20 temporary disc definition structure information associated with the recording medium.

5. The method of claim 2, wherein the recording medium is to be finalized when the TDMA is full and no more management information can be recorded in the
25 TDMA.

6. The method of claim 5, wherein in the transferring step, the latest management information includes latest temporary defect list information and latest temporary disc definition structure information associated with the recording

medium.

7. The method of claim 2, wherein the recording medium is to be finalized in response to a user's request.

5

8. The method of claim 7, wherein in the transferring step, the latest management information includes latest temporary defect list information and latest temporary disc definition structure information associated with the recording medium.

10

9. The method of claim 1, wherein the recording medium further includes a spare area and a user data area, and

wherein in the transferring step, the DMA fill-in stage is when a recordable area remains in the spare area and the TDMA even though no recordable area remains in the user data area of the recording medium, and latest management information of the TDMA at that time is transferred into a first area of the DMA.

15

10. The method of claim 9, further comprising:

transferring and recording latest management information of the TDMA into a second area of the DMA at a second DMA fill-in stage of the recording medium.

20

11. The method of claim 10, wherein the second DMA fill-in stage of the recording medium is when the recording medium is to be finalized.

25

12. The method of claim 11, wherein if the management information is recorded in the first area of the DMA, then a defect management is performed during reproduction of the recording medium; and if the management information is recorded in the second area of the DMA, then a defect management is not performed during reproduction of the recording medium.

13. The method of claim 11, wherein the recording medium is to be finalized when the TDMA is full and no more management information can be recorded in the TDMA.

5

14. The method of claim 13, wherein in at least one of the transferring steps, the latest management information includes latest temporary defect list information and latest temporary disc definition structure information associated with the recording medium.

10

15. The method of claim 11, wherein the recording medium is to be finalized in response to a user's request.

16. The method of claim 15, wherein in at least one of the transferring steps, the latest management information includes latest temporary defect list information and latest temporary disc definition structure information associated with the recording medium.

15

17. The method of claim 1, wherein the recording medium is a writable-once Blu-ray disc (BD-WO).

20

18. The method of claim 1, wherein in the transferring step, the latest management information includes a status flag indicating a type of the DMA fill-in stage.

25

19. A method of recording management information on a write-once optical recording medium, the recording medium including a temporary defect management area (TDMA) and a final defect management area (DMA), the DMA including a defect list area for storing therein defect list information, the method comprising:

if no defect management is to be performed on the recoding medium, setting a predetermined value in the defect list area of the DMA;

recording, in the TDMA, management information produced while the recording medium is in use; and

5 transferring and recording the latest management information of the TDMA in the DMA when the recording medium is to be finalized.

20. The method of claim 19, wherein the DMA further includes a disc definition structure area for storing therein disc definition structure information, and

10 wherein in the transferring step, the latest management information of the TDMA is transferred to the disc definition structure area of the DMA and is latest disc definition structure information associated with the recording medium.

21. The method of claim 19, wherein the recording medium is to be finalized
15 when no more recording in a user data area of the recording medium is allowed.

22. The method of claim 19, wherein the recording medium is to be finalized when the TDMA is full and no more management information can be recorded in the TDMA.

20

23. The method of claim 19, wherein the recording medium is to be finalized in response to a user's request.

24. The method of claim 19, wherein the recording medium is a writable-once
25 Blu-ray disc (BD-WO).

25. The method of claim 19, wherein in the transferring step, the latest management information includes a status flag indicating a type of the finalization of the recording medium.

26. An apparatus for recording management information on a write-once optical recording medium, the recording medium including a temporary defect management area (TDMA) and a final defect management area (DMA), the apparatus comprising:

5 means for recording, in the TDMA, management information produced while the recording medium is in use; and

means for transferring and recording the latest management information of the TDMA in the DMA at a DMA fill-in stage of the recording medium.

10 27. An apparatus for recording management information on a write-once optical recording medium, the recording medium including a temporary defect management area (TDMA) and a final defect management area (DMA), the DMA including a defect list area for storing therein defect list information, the apparatus comprising:

15 means for setting a predetermined value in the defect list area of the DMA if no defect management is to be performed on the recording medium;

means for recording, in the TDMA, management information produced while the recording medium is in use; and

20 means for transferring and recording the latest management information of the TDMA in the DMA when the recording medium is to be finalized.

28. A write-once optical recording medium for recording management information thereon, the recording medium comprising:

25 at least one recording layer including a temporary defect management area (TDMA) and a final defect management area (DMA),

wherein management information produced while the recording medium is in use is recorded in the TDMA, and

the latest management information of the TDMA is transferred and recorded in the DMA at a DMA fill-in stage of the recording medium.

29. The recording medium of claim 28, wherein the DMA fill-in stage of the recording medium is when the recording medium is to be finalized.

5 30. The recording medium of claim 29, wherein the recording medium is to be finalized when no more recording in a user data area of the recording medium is allowed.

10 31. The recording medium of claim 30, wherein the latest management information transferred and recorded in the DMA includes latest temporary defect list information and latest temporary disc definition structure information associated with the recording medium.

15 32. The recording medium of claim 29, wherein the recording medium is to be finalized when the TDMA is full and no more management information can be recorded in the TDMA.

20 33. The recording medium of claim 32, wherein the latest management information transferred and recorded in the DMA includes latest temporary defect list information and latest temporary disc definition structure information associated with the recording medium.

25 34. The recording medium of claim 29, wherein the recording medium is to be finalized in response to a user's request.

 35. The recording medium of claim 34, wherein the latest management information transferred and recorded in the DMA includes latest temporary defect list information and latest temporary disc definition structure information associated with the recording medium.

36. The recording medium of claim 28, wherein the at least one recoding layer further includes a spare area and a user data area, and

5 wherein the DMA fill-in stage is when a recordable area remains in the spare area and the TDMA even though no recordable area remains in the user data area of the recording medium, and latest management information of the TDMA at that time is transferred into a first area of the DMA.

37. The recording medium of claim 36, wherein latest management
10 information of the TDMA is transferred and recorded into a second area of the DMA at a second DMA fill-in stage of the recording medium.

38. The recording medium of claim 37, wherein the second DMA fill-in stage
15 of the recording medium is when the recording medium is to be finalized.

39. The recording medium of claim 38, wherein if the management
information is recorded in the first area of the DMA, then a defect management is performed during reproduction of the recording medium; and if the management
information is recorded in the second area of the DMA, then a defect management is
20 not performed during reproduction of the recording medium.

40. The recording medium of claim 38, wherein the recording medium is to
be finalized when the TDMA is full and no more management information can be
recorded in the TDMA.

41. The recording medium of claim 40, wherein the latest management
information recorded in at least one of the first and second areas of the DMA
includes latest temporary defect list information and latest temporary disc definition
structure information associated with the recording medium.

42. The recording medium of claim 38, wherein the recording medium is to be finalized in response to a user's request.

5 43. The recording medium of claim 42, wherein the latest management information recorded in at least one of the first and second areas of the DMA includes latest temporary defect list information and latest temporary disc definition structure information associated with the recording medium.

10 44. The recording medium of claim 28, wherein the recording medium is a writable-once Blu-ray disc (BD-WO).

 45. The recording medium of claim 28, wherein the latest management information includes a status flag indicating a type of the DMA fill-in stage.

15

 46. A write-once optical recording medium for recording management information thereon, the recording medium comprising:

 at least one recording layer including a temporary defect management area (TDMA) and a final defect management area (DMA), the DMA including a defect
20 list area for storing therein defect list information,

 wherein if no defect management is to be performed on the recording medium, a predetermined value is set in the defect list area of the DMA,

 management information produced while the recording medium is in use is recorded in the TDMA, and

25 the latest management information of the TDMA is transferred and recorded in the DMA when the recording medium is to be finalized.

 47. The recording medium of claim 46, wherein the DMA further includes a disc definition structure area for storing therein disc definition structure information,

and

wherein when the recording medium is to be finalized, the latest management information of the TDMA is transferred to the disc definition structure area of the DMA and is latest disc definition structure information associated with the recording
5 medium.

48. The recording medium of claim 46, wherein the recording medium is to be finalized when no more recording in a user data area of the recording medium is allowed.

10

49. The recording medium of claim 46, wherein the recording medium is to be finalized when the TDMA is full and no more management information can be recorded in the TDMA.

15 50. The recording medium of claim 46, wherein the recording medium is to be finalized in response to a user's request.

51. The recording medium of claim 46, wherein the recording medium is a writable-once Blu-ray disc (BD-WO).

20 52. The recording medium of claim 46, wherein the latest management information includes a status flag indicating a type of the finalization of the recording medium.

FIG. 2

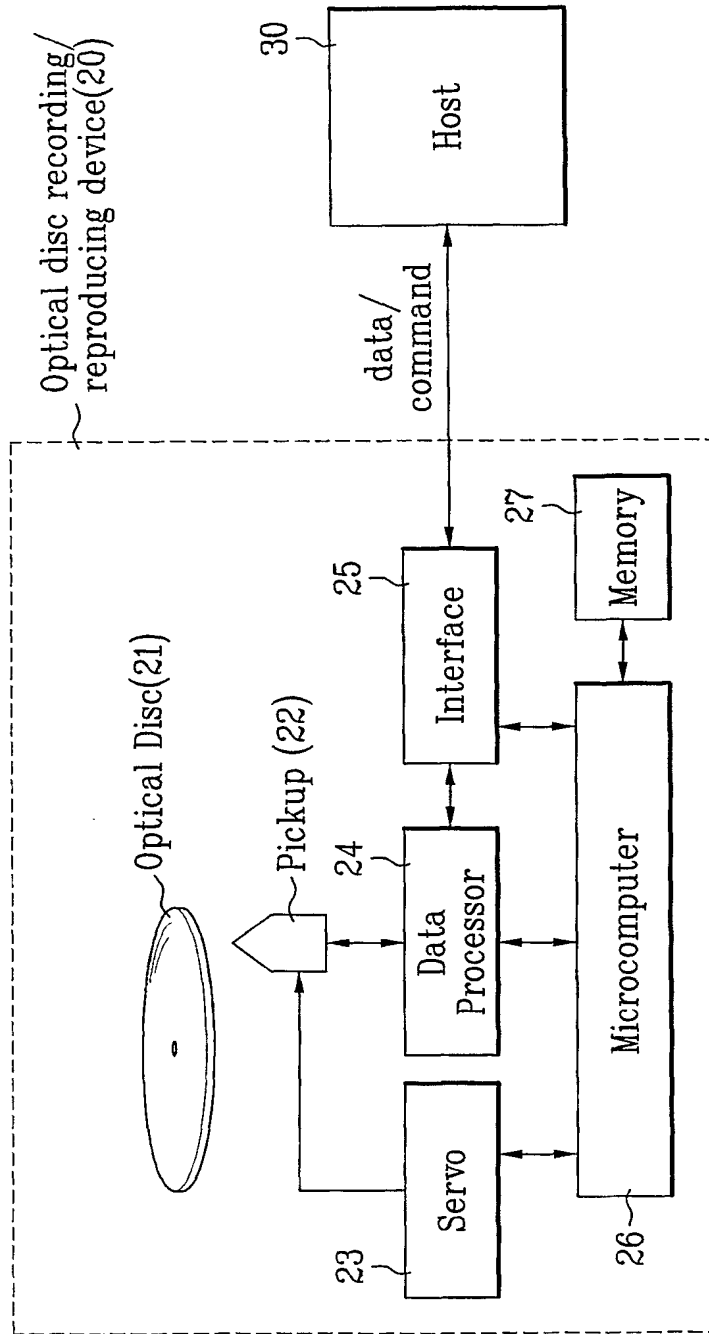

FIG. 3

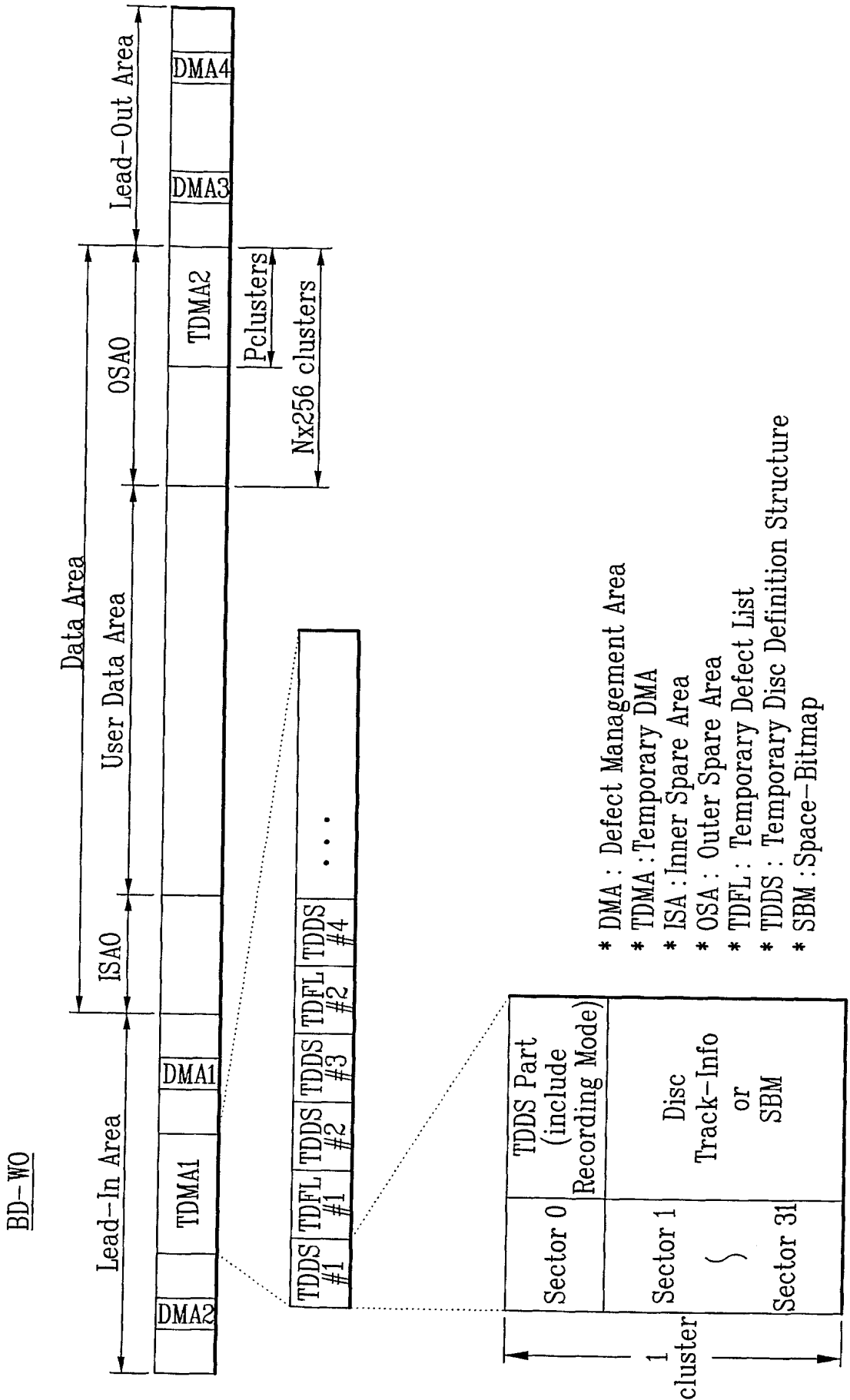
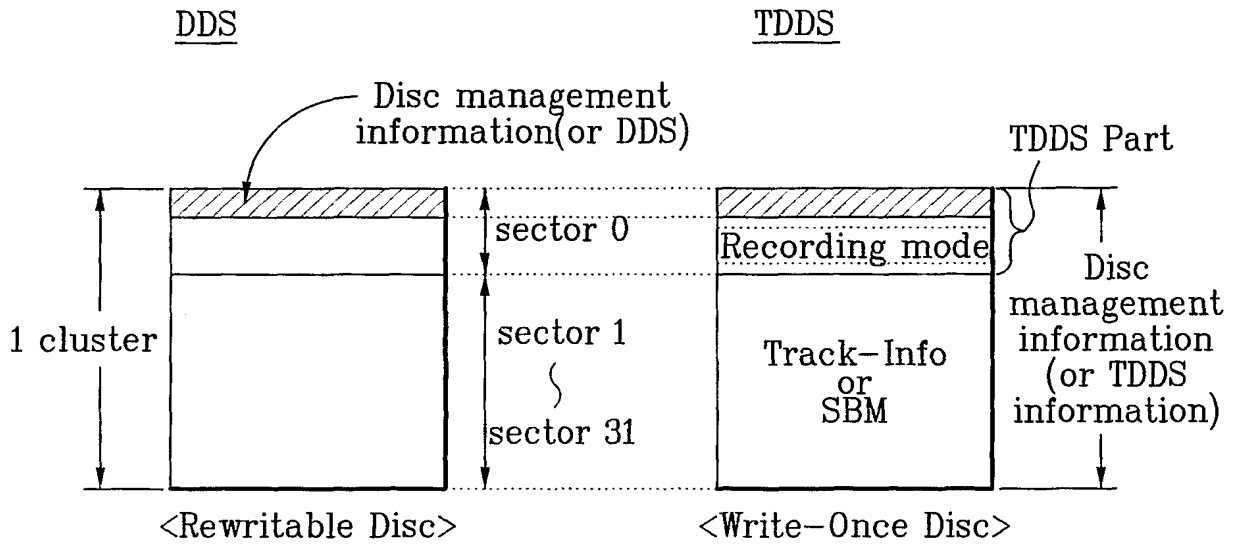

FIG. 4



- * Recording mode
 - 0000 0000b : Sequential Recording
 - 0000 0001b : Random Recording

FIG. 5

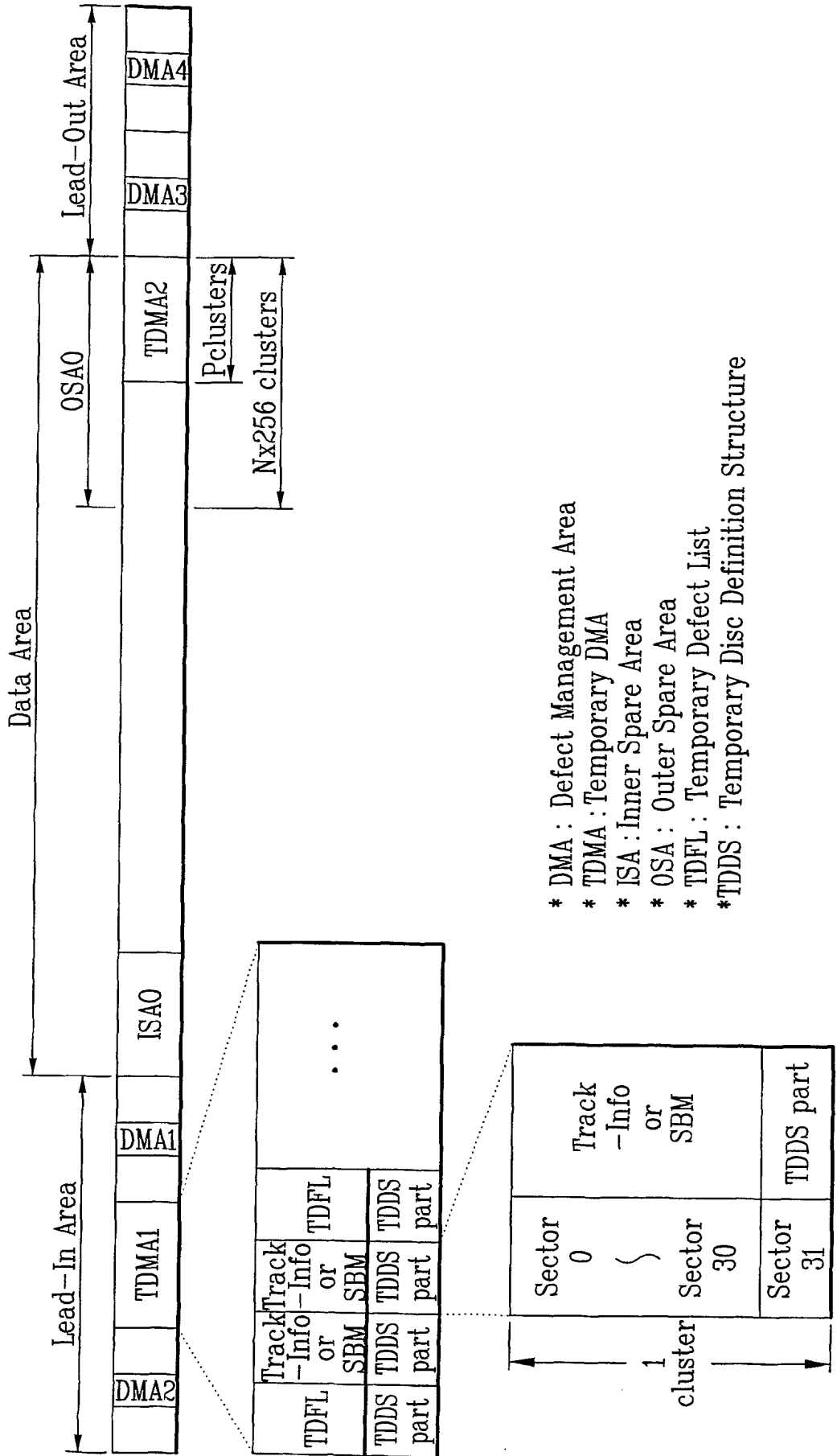

FIG. 6A

Single Layer BD-WO

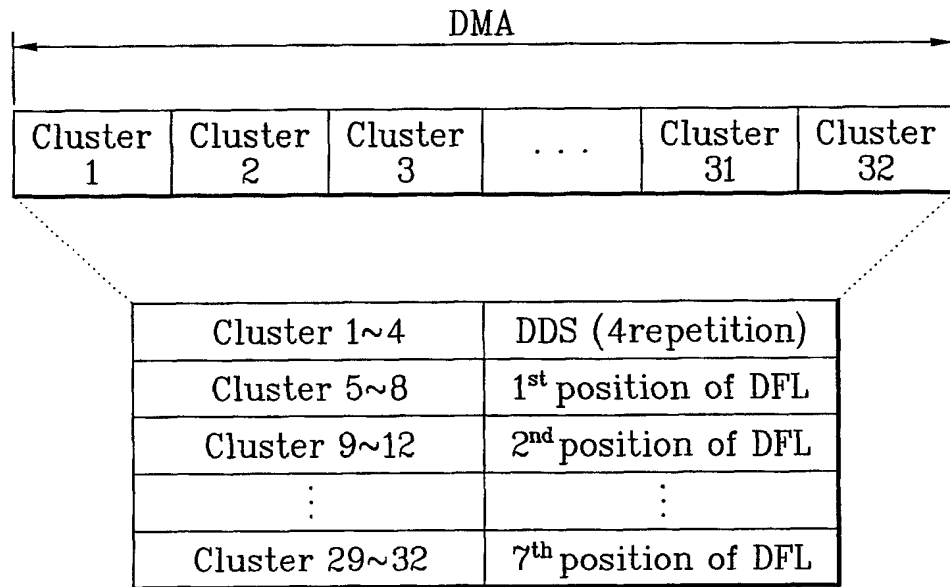

FIG. 6B

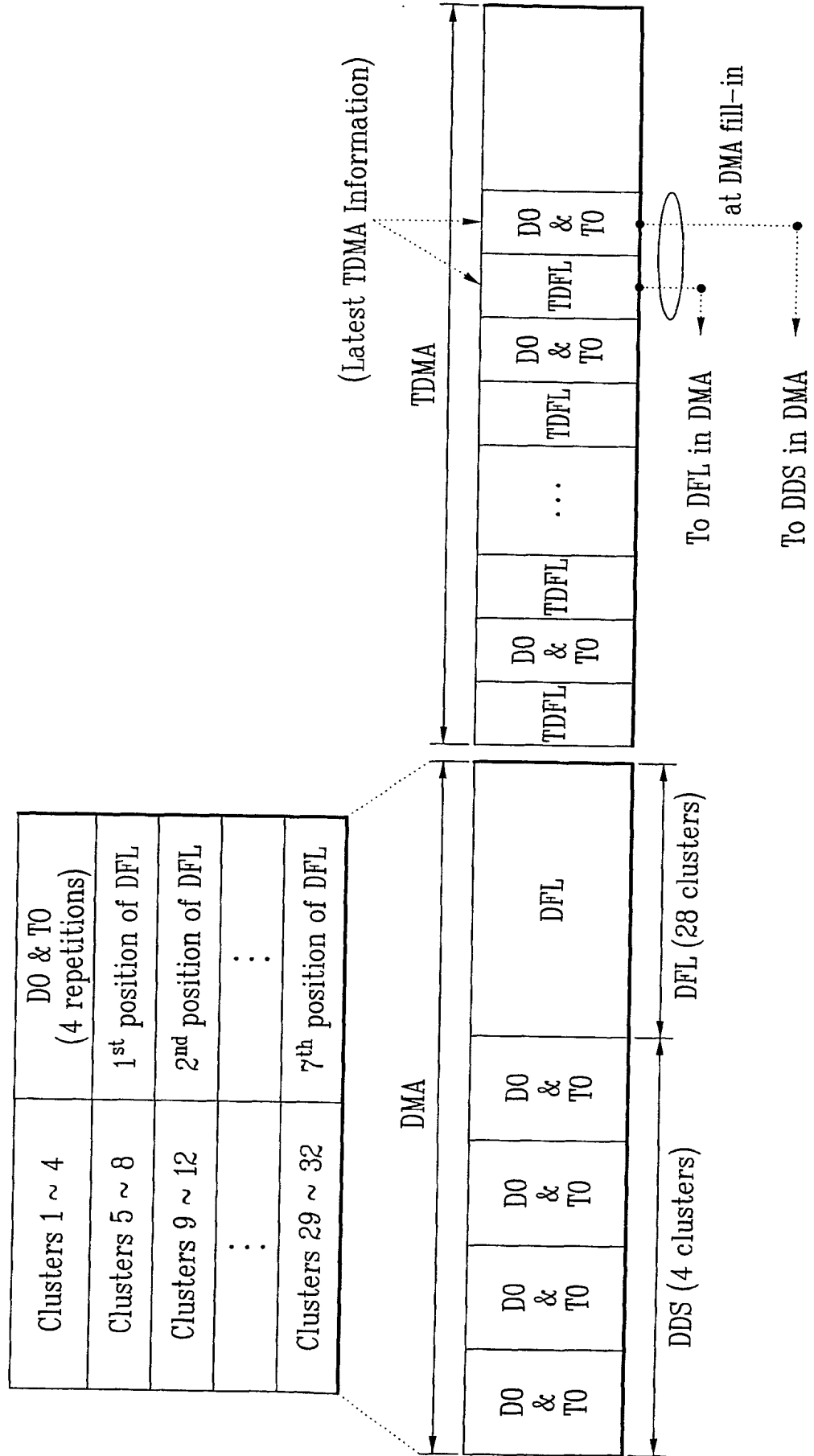

FIG. 6C

Dual Layer BD-WO

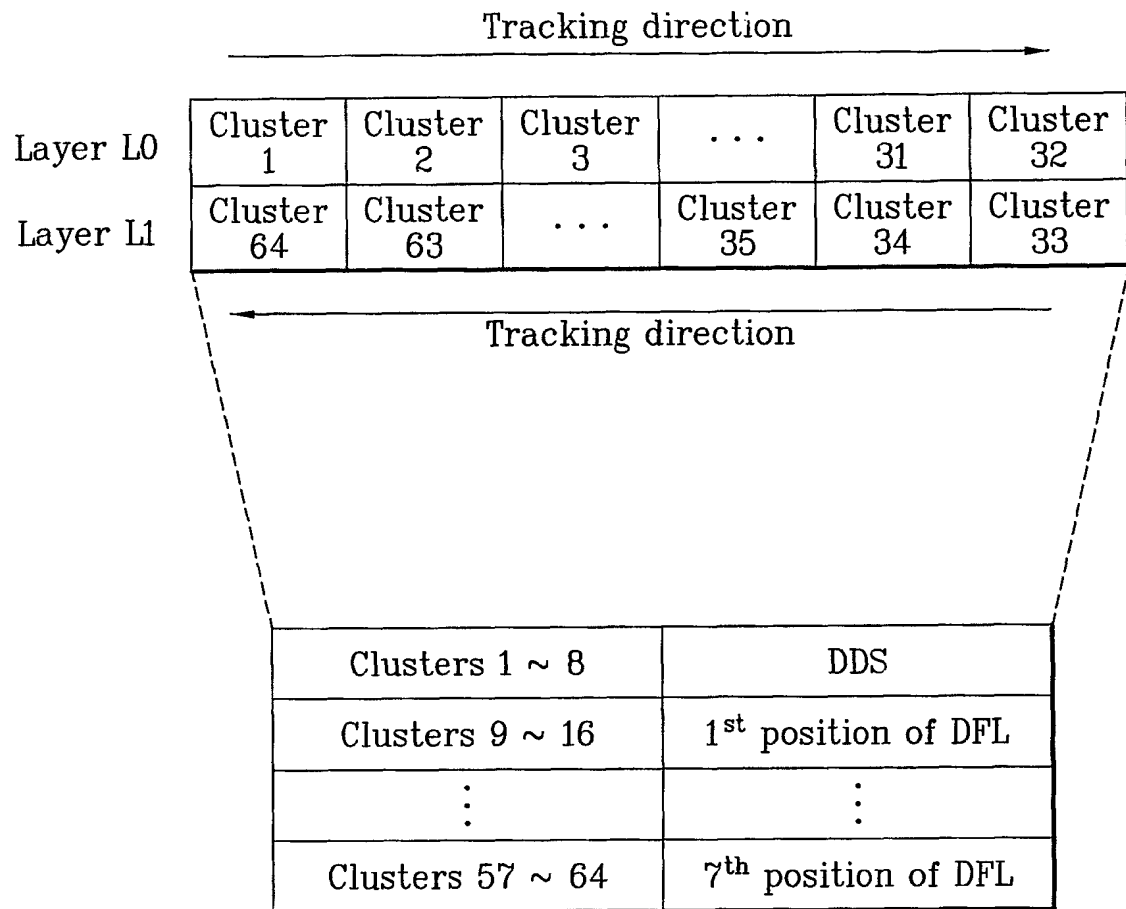

FIG. 7

	DMA fill-in timing	contents	Location in DMA
Finalization	50a No more record	Latest TDDS & TDFL	DDS & DFL
	50b TDMA Full	Latest TDDS & TDFL	DDS & DFL
	50c User selection	Latest TDDS & TDFL	DDS & DFL

FIG. 8

	DMA fill-in timing	contents	Location in DMA
	50d Non D.M	Predetermined Value (ex,zero padding)	DFL
Finalization	50a No more record	Latest TDDS	DDS
	50b TDMA Full	Latest TDDS	DDS
	50c User selection	Latest TDDS	DDS

- D.M : Defect Management
- DMA : Defect Management Area

FIG. 9A

	DMA fill-in timing	contents	Location in DMA
50e	No more record But Spare & TDMA left	Latest TDDS & TDFL	Part of DMA
Finalization	50b TDMA Full	Latest TDDS & TDFL	Remainder of DMA
	50c User selection	Latest TDDS & TDFL	Remainder of DMA

- D.M : Defect Management
- DMA : Defect Management Area

FIG. 9B

Clusters 1 ~ 2	DDS (before Finalization)
Clusters 3 ~ 4	DDS (at Finalization)
Clusters 5 ~ 8	DFL (before Finalization)
Clusters 9 ~ 12	1st position of DFL (at Finalization)
⋮	⋮
Clusters 29 ~ 32	6th position of DFL (at Finalization)

INTERNATIONAL SEARCH REPORT

International application No.
PCT/KR 03/02009-0

CLASSIFICATION OF SUBJECT MATTER

IPC⁷: G11B 7/00, 11/00

According to International Patent Classification (IPC) or to both national classification and IPC

B. FIELDS SEARCHED

Minimum documentation searched (classification system followed by classification symbols)

IPC⁷: G11B 7/00, 11/00

Documentation searched other than minimum documentation to the extent that such documents are included in the fields searched

G11B 7/0045, 11/10, 11/12, 13/04, 20/10, 20/12

Electronic data base consulted during the international search (name of data base and, where practicable, search terms used)

WPI

C. DOCUMENTS CONSIDERED TO BE RELEVANT

Category	Citation of document, with indication, where appropriate, of the relevant passages	Relevant to claim No.
A	US 5805536 A (Gage et al.) 8 September 1998 (08.09.98)	1,19,26-28,46
A	US 5247494 A (Ohno et al.) 21 September 1993 (21.09.93)	1,19,26-28,46
A	EP 0556046 A1 (Sony) 18 August 1993 (18.08.93)	1,19,26-28,46

Further documents are listed in the continuation of Box C.

See patent family annex.

* Special categories of cited documents:

- „A“ document defining the general state of the art which is not considered to be of particular relevance
- „E“ earlier application or patent but published on or after the international filing date
- „L“ document which may throw doubts on priority claim(s) or which is cited to establish the publication date of another citation or other special reason (as specified)
- „O“ document referring to an oral disclosure, use, exhibition or other means
- „P“ document published prior to the international filing date but later than the priority date claimed

- „T“ later document published after the international filing date or priority date and not in conflict with the application but cited to understand the principle or theory underlying the invention
- „X“ document of particular relevance; the claimed invention cannot be considered novel or cannot be considered to involve an inventive step when the document is taken alone
- „Y“ document of particular relevance; the claimed invention cannot be considered to involve an inventive step when the document is combined with one or more other such documents, such combination being obvious to a person skilled in the art
- „&“ document member of the same patent family

Date of the actual completion of the international search

23 January 2004 (23.01.2004)

Date of mailing of the international search report

12 February 2004 (12.02.2004)

Name and mailing address of the ISA/AT
Austrian Patent Office
Drosdner Straße 87, A-1200 Vienna
Facsimile No. 1/53424/535

Authorized officer

GRÖSSING G.

Telephone No. 1/53424/386

Form PCT/ISA/210 (second sheet) (July 1998)

INTERNATIONAL SEARCH REPORT

Information on patent family members

International application No.
PCT/KR 03/02009-0

Patent document cited in search report	Publication date	Patent family member(s)	Publication date
EP A 556046		KR B 275000 DE T 69318053T DE D 69318053D US A 5309419 EP A 0556046 JP A 5225570	2000-12-15 1998-08-20 1998-05-28 1994-05-03 1993-08-18 1993-09-03
US A 5247494	1993-09-21	JP A 60263353	1985-12-26
US A 5805536	1998-09-08	none	